

# Instruction Manual

## Turbo Controller



Description	Item Number
TIC Turbo Controller 100 W	D397-11-000
TIC Turbo Controller 200 W	D397-12-000





# Declaration of Conformity

We, Edwards Limited,  
Crawley Business Quarter,  
Manor Royal,  
Crawley,  
West Sussex RH10 9LW, UK

declare under our sole responsibility, as manufacturer and person within the EU authorised to assemble the technical file, that the product(s)

TIC Instrument Controller	D397-00-000
TIC Instrument Controller 6-Gauge	D397-01-000
TIC Instrument Controller 6-Gauge Capacitance Manometer	D397-02-000
TIC Turbo Controller 100W	D397-11-000
TIC Turbo Controller 200W	D397-12-000
TIC Turbo & Instrument Controller 100W	D397-21-000
TIC Turbo & Instrument Controller 200W	D397-22-000

to which this declaration relates is in conformity with the following standard(s) or other normative document(s)

EN61010-1:2010	Safety Requirements for Electrical Equipment for Measurement, Control and Laboratory Use - Part 1: General Requirements.
EN61326-1:2006 (Industrial location, Class B Emissions)	Electrical Equipment for Measurement Control and Laboratory Use - EMC Requirements.
CAN/CSA-C22.2 No.61010-1-04	Safety requirements for electrical equipment for measurement, Control and laboratory use - Part 1: General requirements
UL61010-1, 2 <sup>nd</sup> Edition	Safety requirements for electrical equipment for measurement, Control and laboratory use - Part 1: General requirements

and fulfils all the relevant provisions of

2006/95/EC	Low Voltage Directive.
2004/108/EC	Electromagnetic Compatibility Directive.
2012/19/EU	Waste from Electrical and Electronic Equipment (WEEE) Directive

*Note: This declaration covers all product serial numbers from the date this Declaration was signed onwards.*

*L G Marini*

17/10/2013, Eastbourne

Mr L Marini, Senior Technical Manager

Date and Place

This product has been manufactured under a quality system certified to ISO9001:2008

# Contents

Section	Page
<b>1</b>	<b>Introduction</b> ..... 1
1.1	Scope and definitions ..... 1
1.2	Product description ..... 1
<b>2</b>	<b>Technical data</b> ..... 3
2.1	Electrical data ..... 3
2.2	Operating and storage data ..... 3
2.3	Mechanical data ..... 3
2.4	Connections ..... 4
2.4.1	Turbo pump connector ..... 4
2.4.2	Backing pump connector ..... 5
2.4.3	Auxiliary terminals ..... 6
2.4.4	Logic interface ..... 7
2.4.5	Serial communications ..... 8
<b>3</b>	<b>Installation</b> ..... 9
3.1	Unpack and inspect ..... 9
3.2	Fitting the controller ..... 9
3.3	Controller electrical connections ..... 12
3.3.1	Connecting the electrical supply ..... 12
3.3.2	Additional earth bonding ..... 12
3.3.3	Connecting a turbo pump ..... 13
3.3.4	Connecting a backing pump ..... 13
3.3.5	Connecting a vent valve ..... 13
3.3.6	Connecting an air cooler ..... 13
3.3.7	Connecting the logic interface ..... 13
3.3.8	Connecting the serial interface ..... 15
<b>4</b>	<b>Operation</b> ..... 17
4.1	Front panel description ..... 17
4.2	Menu structure ..... 18
4.3	Navigating the menu ..... 19
4.4	The view screen ..... 20
4.5	Turning pumps and relays on/off ..... 21
4.6	Changing list items ..... 21
4.7	Changing numerical values ..... 21
4.8	Turbo set up ..... 21
4.8.1	Introduction ..... 21
4.8.2	Default turbo set up options ..... 22
4.8.3	Additional set up options using a DX or nEXT pump ..... 23
4.9	Backing set up ..... 25
4.10	Alarms ..... 25
4.11	The main menu ..... 26
4.12	Turbo status ..... 26
4.13	Backing status ..... 27
4.14	Parameters/units ..... 28
4.15	Relay setpoint outputs ..... 28
4.16	Service information ..... 29
4.17	Electrical supply failure ..... 29

5	Maintenance .....	31
5.1	Safety .....	31
5.2	Fault finding .....	31
5.3	Cleaning the controller .....	31
5.4	Software updates .....	32
5.5	Factory defaults .....	32
6	Storage and disposal .....	33
6.1	Storage .....	33
6.2	Disposal .....	33
7	Service, spares and accessories .....	35
7.1	Service .....	35
7.2	Spares .....	35
7.3	Accessories .....	35
	Index .....	37

For return of equipment, complete the HS Forms at the end of this manual.

## Illustrations

Figure		Page
1	Pin connections for a 15-way sub-miniature 'D' type socket .....	4
2	Pin connections for a 15-way sub-miniature 'D' type socket .....	5
3	4-way screw terminal block .....	6
4	Pin connections for a 25-way sub-miniature 'D' type socket .....	7
5	Pin connections for a 9-way sub-miniature 'D' type socket .....	8
6	Bench mounted TIC dimensions (mm) .....	10
7	Front panel removal .....	10
8	Rack mounting of a TIC .....	11
9	Panel cut out drawing .....	11
10	Rear panel connections .....	12
11	IBM PC RS232 interface - 9-way .....	15
12	IBM PC RS232 interface - 25 way .....	16
13	RS485 TIC network .....	16
14	Front panel display .....	17
15	View screen shortcuts .....	18
16	Menu structure .....	19
17	Pump status .....	20
18	Changing numerical values .....	21
19	Turbo set up screen .....	22

# Tables

Table	Page
1	Compatible equipment for the TIC range ..... 2
2	Turbo pump connector pin-out ..... 4
3	Backing pump connector pin-out ..... 5
4	Auxiliary connector pin-out ..... 6
5	Logic interface connector pin-out ..... 7
6	Serial communications connector pin-out ..... 8
7	Checklist of components ..... 9
8	Front panel symbols and their functions ..... 17
9	Default turbo setup options ..... 22
10	Error/diagnostic monitoring, pumps ..... 23
11	Turbo pump vent options ..... 23
12	DX, nEXT and nXDS pump set up options ..... 24
13	Error/diagnostic monitoring, DX, nEXT and nXDS pumps ..... 24
14	Default Backing set up options ..... 25
15	nXDS pump set up options ..... 25
16	nEXT Service Screen ..... 26
17	nEXT Service Reset Screen ..... 26
18	nXDS Service Screen ..... 27
19	nXDS Service Reset Screen ..... 27
20	Fault finding ..... 31
21	Factory default settings ..... 32
22	Accessories ..... 35

This page has been intentionally left blank.

# 1 Introduction

## 1.1 Scope and definitions

This manual provides Installation, Operation and Maintenance instructions for the Edwards Turbo Controller. You must use the Controller as specified in this manual.

Read this manual before you install and operate the Edwards Turbo Controller. Important safety information is highlighted as WARNING and CAUTION instructions; you must obey these instructions. The use of WARNINGS and CAUTIONS is defined below.



### **WARNING**

Warnings are given where failure to observe the instruction could result in injury or death to people.

---

### **CAUTION**

Cautions are given where failure to observe the instruction could result in damage to the equipment, associated equipment and process.

---

Throughout this manual, page, figure or table numbers are sequential.

The following IEC warning labels appear on the controller:



Warning - refer to accompanying documentation.



Edwards offer European customers a recycling service.

## 1.2 Product description



### **WARNING**

Improper use of the equipment could cause damage to it or injury to people. The user is responsible for the safe operation and monitoring of the equipment. Hazardous voltages should not be connected to this unit except where specified.

---

There are two variants of the Turbo Controller, both of which are provided with a large clear graphics display, easy-to-use control interface via a touch sensitive keypad, an RS232/485 interface for control and data monitoring on a remote PC and a logic interface for interface with associated system hardware.

The compatible pumps/accessories that can be used with the Turbo Controller are listed in [Table 1](#).

Table 1 - Compatible equipment for the TIC range

TIC variant	Compatibility
TIC Turbo Controller 100 W	EXT75DX - fast ramp EXT255DX - slow ramp nEXT-P2 - slow ramp EXT70H + EXDC80 - fast ramp EXT255H + EXDC80 - slow ramp Mains backing pumps, XDS scroll, up to RV12 (via an optional relay box) Air Cooler, ACX70 and ACX250 Vent Valve, TAV5 and TAV6 Bakeout band (via an optional relay box) 24 V backing line valves, LCPV16EKA and LCPV25EKA (via an optional relay box)
TIC Turbo Controller 200 W	Same as the 100 W version plus the following: 24 V backing pump EXT255H + EXDC160 - fast ramp EXT255DX - fast ramp nEXT-P2 - fast ramp



## 2 Technical data

### 2.1 Electrical data

Connector type	CEE/IEC 320
Electrical supply	90 to 264 V a.c. 47 to 63 Hz
Power consumption	
TIC Turbo Controller 100 W	215 VA maximum (D397-11-000)
TIC Turbo Controller 200 W	350 VA maximum (D397-12-000)
Peak inrush current	11 A at 110 V a.c.                    } D397-11-000 23 A at 240 V a.c.                    } D397-12-000
Fuse	The unit is self-protecting and has no user replaceable fuse. The unit will recover once any overload is removed.
Earth Stud	M4

### 2.2 Operating and storage data

Ambient operating temperature range	0 °C to 40 °C
Ambient storage temperature range	-30 °C to 70 °C
Maximum ambient operating humidity	Max 90% RH non condensing at 40 °C
Maximum operating altitude	3000 m max
IP rating	20

### 2.3 Mechanical data

Weight	
TIC Turbo Controller 100 W	1.8 kg
TIC Turbo Controller 200 W	1.9 kg

## 2.4 Connections

### 2.4.1 Turbo pump connector

Connector type	15-way sub-miniature 'D' type socket (refer to Figure 1)
Power supply	24 V d.c.
Maximum output power	100 W TIC: 80 W continuous, 120 W peak 200 W TIC: 160 W continuous, 240 W peak (combined total power of the 24 V turbo and backing pumps)
Input voltage range	-0.5 V to 15 V
Output ID current	33 µA, 0 V to 13 V
Control output	active: <1.1 V d.c. ( $I_{out}$ 20 mA max) <0.8 V d.c. ( $I_{out}$ <2 mA) inactive: open (<24 V d.c. externally applied)
Control input	low: <4.0 V d.c. ( $I_{out}$ <160 µA) high: 7.0 V to 24 V d.c. (internally pulled up to 24 V)
RS232 transmit	disabled: open enabled: 0: > +8 V ( $I_{out}$ max: 8 mA) 1: < -8 V ( $I_{out}$ max: -8 mA)
RS232 receive	mark: <4.0 V d.c. ( $I_{out}$ < 160 µA) space: 7.0 V to 24 V d.c. (internal pull up to 24 V)
Maximum cable length	7 m

Figure 1 - Pin connections for a 15-way sub-miniature 'D' type socket

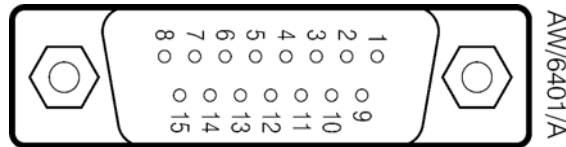

Table 2 - Turbo pump connector pin-out

Pin	Allocation
1	Power supply positive
2	Signal common
3	/Start signal output
4	RS232 Tx
5	/Serial enable output
6	Power supply positive
7	RS232 Rx
8	Power supply common
9	Speed signal input
10	Screen
11	Power supply positive
12	Screen
13	Power supply common
14	Power supply common
15	Normal signal input

## 2.4.2 Backing pump connector

*Note:* Only applicable to the 200 W TIC

Connector type	15-way sub-miniature 'D' type socket (refer to Figure 2)	
Power supply	24 V d.c.	
Maximum output power	160 W continuous, 240 W peak (combined total power of the 24 V turbo and backing pumps)	
Output voltage range	Stop = 0 V Start = 10 V (5 mA maximum)	
Output ID current	33 $\mu$ A, 0 V to 13 V	
Control output	active:	<1.1 V d.c. ( $I_{out} < 20$ mA) <0.8 V d.c. ( $I_{out} < 2$ mA)
	inactive:	open (<24 V d.c. externally applied)
Control input	low:	<4.0 V d.c. ( $I_{out} < 160$ $\mu$ A)
	high:	7.0 to 24 V d.c. (internally pulled up to 24 V)
RS232 transmit	disabled:	open
	enabled:	0: > +8 V ( $I_{out}$ max: 8 mA) 1: < -8 V ( $I_{out}$ max: -8 mA)
RS232 receive	mark:	<4.0 V d.c. ( $I_{out} < 160$ $\mu$ A)
	space:	7.0 V to 24 V d.c. (internal pull up to 24 V)
Maximum cable length	7 m	

Figure 2 - Pin connections for a 15-way sub-miniature 'D' type socket

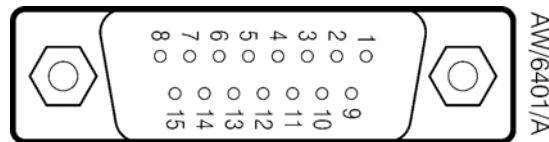

Table 3 - Backing pump connector pin-out

Pin	Allocation
1	Power supply positive
2	Signal common
3	/Start signal output
4	RS232 Tx
5	/Serial enable output
6	Power supply positive
7	RS232 Rx
8	Power supply common
9	Speed signal input
10	Screen
11	Power supply positive
12	Screen
13	Power supply common
14	Power supply common
15	Normal signal input

### 2.4.3 Auxiliary terminals

Connector type	4-way screw terminal block (refer to Figure 3)	
Wire size	1.5 mm <sup>2</sup> max	
Power supply	24 V d.c.	
Maximum output power	Fan:	3 W max
	Vent-valve:	2 W max
Control output	active:	<1.5 V d.c.
	inactive:	open
Maximum cable length	10 m	

Figure 3 - 4-way screw terminal block

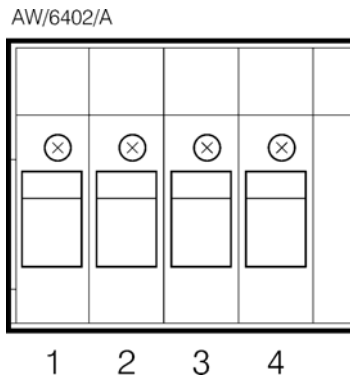

Table 4 - Auxiliary connector pin-out

Pin	Allocation
1	Fan control output
2	Fan 24 V
3	Vent control output
4	Vent 24 V

### 2.4.4 Logic interface

Connector type	25-way sub-miniature 'D' type socket (refer to Figure 4)
Power supply	24 V d.c.
Maximum output power	5 W
Control output	active: <math><1.1\text{ V d.c. (I}_{\text{out}} < 20\text{ mA}</math> <math><0.8\text{ V d.c. (I}_{\text{out}} < 2\text{ mA}</math>
	inactive: open (internal pull up to 24 V)
Control input	low: <math><2.0\text{ V d.c. (I}_{\text{out}} < 160\text{ }\mu\text{A}</math> high: 3.5 V to 24 V d.c. (internal pull up to 24 V)
Analogue output	0 to 10 V (5 mA max) 50 mV resolution

Figure 4 - Pin connections for a 25-way sub-miniature 'D' type socket

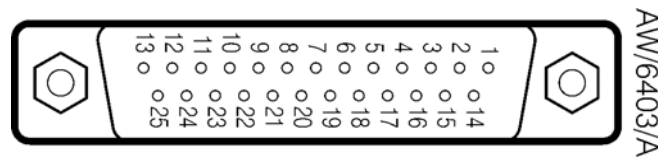

Table 5 - Logic interface connector pin-out

Pin	Allocation
1	Screen
2	Analogue output signal
3	Setpoint 1 output
4	Vent control output
5	Bakeout band control output
6	N/C
7	Power supply common
8	Backing pump control output
9	N/C
10	Power supply common
11	Power supply positive
12	Power supply common
13	Power supply common
14	Analogue output common
15	Setpoint 2 output
16	Setpoint 3 output
17	Turbo normal output
18	Alarm output
19	Air cooler output
20	N/C
21	N/C
22	Backing pump enable input
23	Turbo stand-by control input
24	Turbo pump enable input
25	System interlock input (SYSI)

### 2.4.5 Serial communications

Connector type	9-way sub-miniature 'D' type socket (refer to Figure 5)	
RS232 transmit	mark:	< - 8 V ( $I_{out}$ max: -8 mA)
	space:	> +8 V ( $I_{out}$ max: -8 mA)
RS232 receive	mark:	< +1.0 V ( $I_{in}$ max: -2.0 mA)
	space:	>+2.0 V ( $I_{in}$ max: +2.0 mA)
	maximum input: $\pm 12$ V	
RS232 protocol	9600 baud, 1 stop bit, 8 data bits, no parity	
RS485	Output differential:	>1.5 V ( $I_{out}$ max: $\pm 25$ mA)
	Input differential threshold:	> $\pm 0.2$ V ( $I_{in}$ max: $\pm 1$ mA)
	Maximum input:	-7.0 V to +12 V
Bus load	The TIC applies one unit load to the RS485 bus.	

Figure 5 - Pin connections for a 9-way sub-miniature 'D' type socket

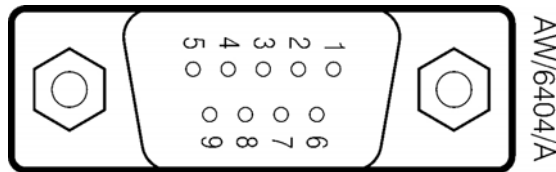

Table 6 - Serial communications connector pin-out

Pin	Allocation
1	N/C
2	RS232 transmit
3	RS232 receive
4	N/C
5	RS232 common
6	N/C
7	N/C
8	RS485 data A
9	RS485 data B

## 3 Installation

### 3.1 Unpack and inspect

Remove all of the packaging material and check the Controller. If the Controller is damaged, follow the Edwards return of equipment procedures that are laid out in the back of this manual. Do not use the Controller if it is damaged.

Check that your package contains the items that are listed in [Table 7](#). If any of these items are missing, notify your supplier in writing within three days. If the Controller is not to be used immediately, store the Controller in suitable conditions as described in [Section 6.1](#).

Table 7 - Checklist of components

Quantity	Description	Check (✓)
1	Controller	<input type="checkbox"/>
1	Quick Guide and Health and Safety Information	<input type="checkbox"/>
1	TIC CD	<input type="checkbox"/>
2	Rear non-slip feet	<input type="checkbox"/>
1	Logic interface plug	<input type="checkbox"/>

### 3.2 Fitting the controller



#### **WARNING**

If access to the IEC connector is restricted an additional isolation device should be provided, which will be easily accessible by an operator.

#### **CAUTION**

Rubber feet must be fitted ([Figure 6](#), item 1) so that there are correct clearances for air circulation. If you do not, the performance of the Controller may be affected at high operating temperatures.

The Controller can be used on a bench-top or can be fitted in a rack or cabinet. [Figure 6](#) shows the dimensions of the TIC that are required for bench top use.

*Note:* If the interlocks are not used the logic interface adaptor must be fitted to the 25-way connector.

Figure 6 - Bench mounted TIC dimensions (mm)

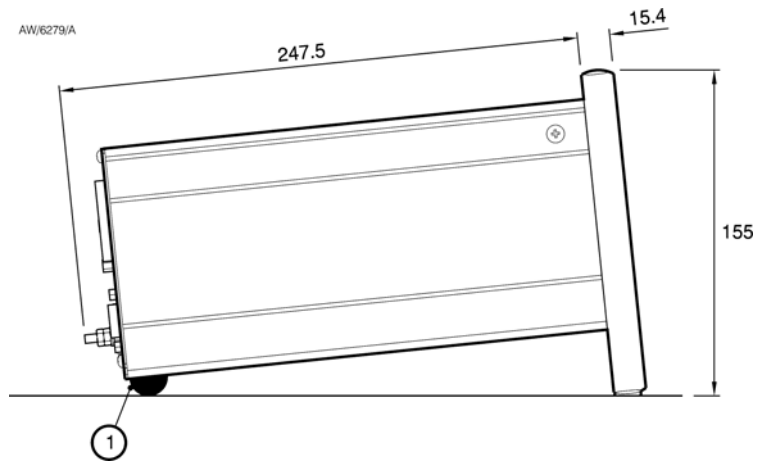

**WARNING**

Ensure that all electrical wiring is safely secured so that people cannot trip on them.

If a Controller is fitted in a rack, cabinet or panel, follow the directions given in Figure 7, 8 and 9.

**CAUTION**

Allow 150 mm at the rear for cables. Allow 50 mm top and bottom and 15 mm to the sides for sufficient air circulation. Do not cover any of the ventilation holes.

**CAUTION**

This unit is IP20 rated. Please ensure that the unit is not installed where fluids can enter into the controller.

**CAUTION**

The unit must be supported at the rear.

Figure 7 - Front panel removal

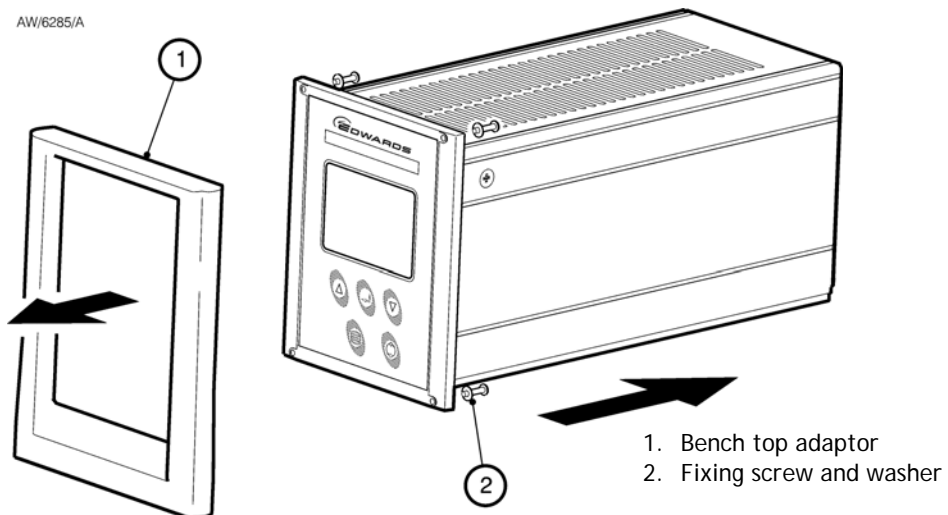



- Remove the bench top adaptor (Figure 7, item 1) by removing the four screws (Figure 7, item 2).
- Slide the Controller into the 19" rack or panel cut out. The use of 19" rack guide rails (Figure 8, item 2) and support at the rear of the Controller is recommended as shown in Figure 8. The panel cut out information is defined in Figure 9.
- Fix the Controller in place using the four screws removed previously (Figure 8, item 1).

Figure 8 - Rack mounting of a TIC

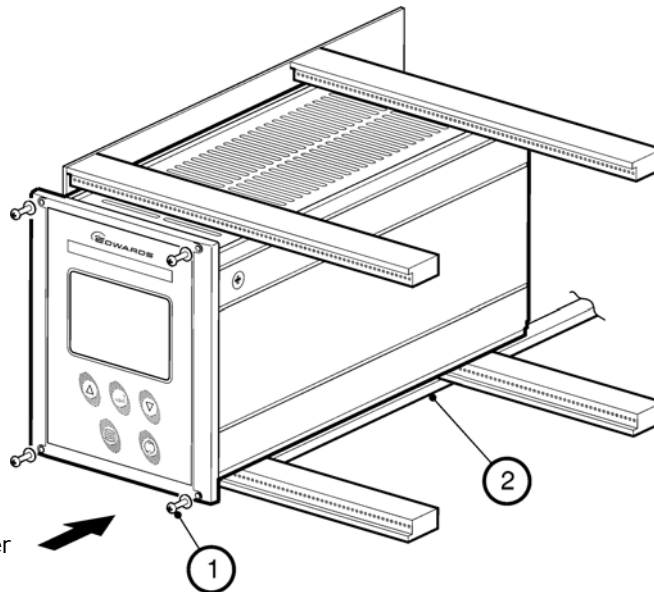

1. Fixing screw and washer
2. 19" rack guide rails

AS-1137-A

Figure 9 - Panel cut out drawing

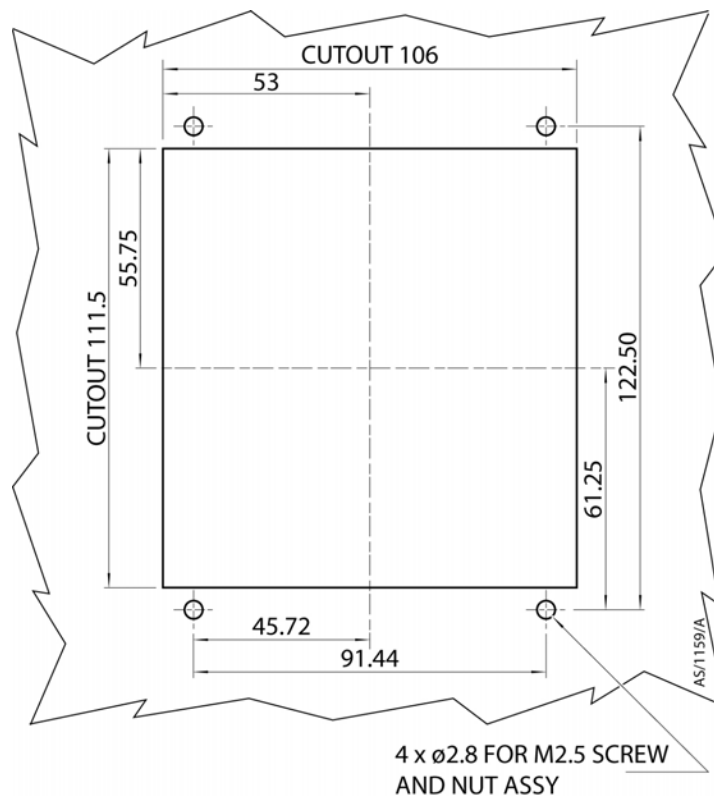

### 3.3 Controller electrical connections

Figure 10 - Rear panel connections

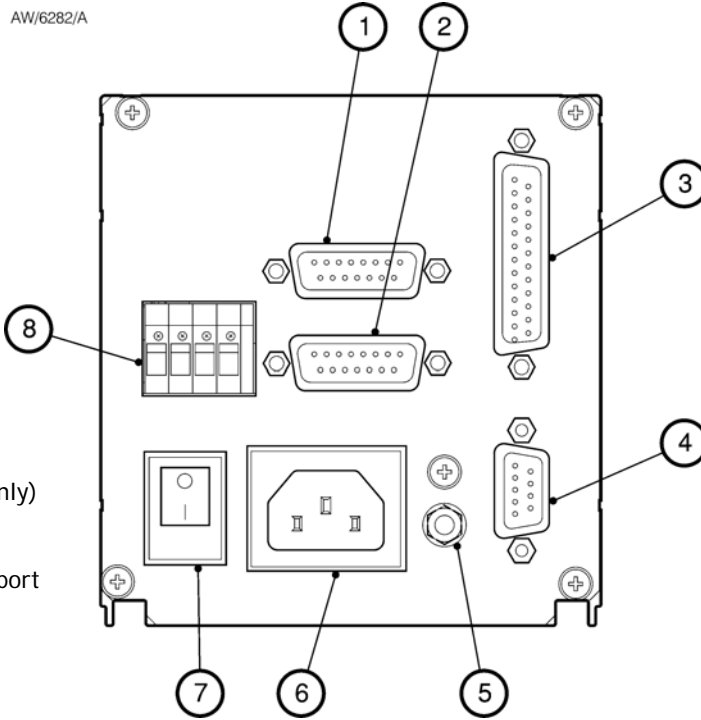

- 1. Backing pump (200 W only)
- 2. Turbo pump connection
- 3. Logic interface
- 4. Serial communications port
- 5. Earth stud
- 6. Mains input
- 7. Mains on/off
- 8. Auxiliary terminals

#### 3.3.1 Connecting the electrical supply



#### WARNING

High voltages exist in the Controller when it is operating. Ensure that the Controller is earthed and observe all appropriate safety precautions for the safe installation and handling of electrical equipment. If you do not, there will be a danger of injury or death to people by electric shock.

Ensure that the electrical supply switch is set to 'off' and then connect the Controller to the electrical supply with an appropriate supply cable.

#### 3.3.2 Additional earth bonding

The electrical supply cable normally provides protective earthing for electrical safety. If this is not the case, or if additional earth bonding is required, then the earth stud on the rear of the Controller (Figure 10, item 5) should be connected to your vacuum system earth.

The earth connection of any vent valves or air coolers should also be connected to this earth stud to ensure that they are adequately earthed.

Connect a suitably earthed cable between the two nuts fitted to the earth stud on the rear of the TIC.

*Note:* Do not remove the bottom nut from the earth stud.

### 3.3.3 Connecting a turbo pump

---

#### CAUTION

Pumps are not hot swap safe unless explicitly stated in their manual. Before connecting or disconnecting a pump to the TIC turn the power off. Failure to do so may damage the pump.

---

The TIC will only identify the pump connected at power on.

A suitable turbo pump can be connected to the TIC turbo pump connector on the rear panel.

Connect the pump to the lower of the two 15 way 'D' connectors and tighten the locking screws to ensure the connector cannot come loose.

### 3.3.4 Connecting a backing pump

Both the 100 W and 200 W TICs can control a mains backing pump via the logic interface. For details of this, refer to [Section 3.3.7.3](#).

The 200 W TIC can also drive a suitable backing pump from it's second rear panel pump connector.

Connect the pump to the upper of the two 15 way 'D' connectors and tighten the locking screws to ensure the connector cannot come loose.

*Note: To control an XDD1 24 V backing pump, the pump must be configured for 'analogue speed control'. Please refer to the pump instruction manual for details on how to configure the pump for this operating mode.*

### 3.3.5 Connecting a vent valve

A vent valve can be driven from either the auxiliary terminals on the rear of the TIC, or from the logic interface. For details of using the logic interface to control a vent valve, see [Section 3.3.7.3](#).

*Note: If a DX or nEXT pump is to be used, it is recommended that the vent valve is connected to the pump, not the TIC Controller. If two vent valves are required, both the DX and TIC vent outputs can be used at the same time. (Refer to [Table 11](#)).*

Connect the positive lead of the vent valve to the terminal marked 'Vent +', connect the negative lead of the vent valve to the terminal marked 'Vent -', and clamp the earth wire between the earth stud locking nuts on the rear of the controller. Ensure the screws and the earth terminal locking nut, are all firmly tightened.

### 3.3.6 Connecting an air cooler

An air cooler can be driven from either the auxiliary terminals on the rear of the TIC, or from the logic interface. For details of using the logic interface to control an air cooler, refer to [Section 3.3.7.3](#).

Connect the positive lead of the air cooler to the terminal marked 'Fan +', connect the negative lead of the air cooler to the terminal marked 'Fan -', and clamp the earth wire between the earth stud locking nuts on the rear of the controller. Ensure the screws and the earth terminal locking nut, are all firmly tightened.

### 3.3.7 Connecting the logic interface

#### 3.3.7.1 Introduction

*Note: In most applications it will be preferable not to earth the logic interface power supply common to prevent earth loops inadvertently occurring.*

---

#### CAUTION

Do not connect voltages greater than 24 V to the logic interface.

---

The logic interface provides a number of signals that can be used for monitoring the status of your vacuum system, and for controlling certain aspects of its operation. These signals can be broadly divided into three groups, control inputs, control outputs and status outputs.

### 3.3.7.2 Using control inputs

Control inputs provide a means of controlling the operation of the TIC and the associated vacuum system from external sources.

**Turbo Stand-by:** To cause the turbo pump to run at stand-by speed, link 'Turbo Stand-by' to 0 V. To return the pump to full speed, disconnect 'Turbo Stand-by' from 0 V. Note only pumps that have stand-by speed capability will respond to this input.

**Turbo Enable:** The turbo enable input can be used to control the operation of the turbo pump. If turbo enable is open, the turbo pump cannot be started, and will stop if it is running. If turbo enable is connected to 0 V when power is applied to the TIC, the pump is able to start when commanded to do so. If turbo enable is connected to 0 V while the controller is operating, the turbo pump will start, as long as SYSI and the software configuration allow it to do so.

**Backing Pump Enable:** The backing pump enable input can be used to control the operation of the backing pump. If backing pump enable is open, the backing pump cannot start, and will stop if it is running. If backing pump enable is connected to 0 V when power is applied to the TIC, the pump is able to start when commanded to do so. If backing pump enable is connected to 0 V while the controller is operating, the backing pump will start, as long as 'SYSI' and the software configuration allow it to do so.

**SYSI:** The System interlock input can be used to interlock the TIC to a system fail or control signal. When 'SYSI' is open, all pumps will stop and the vent valve will be opened. The TIC will also trip into the fail condition. To clear the system interlock and allow the pumps and gauges to start, connect 'SYSI' to 0 V.



#### **WARNING**

'SYSI' is not fail safe and should not be relied upon for safety critical applications.

### 3.3.7.3 Using control outputs

Control outputs provide a means for the TIC to control external resources.

**Vent valve control:** The vent valve output can be used to control the operation of a vent valve. The 'Vent Valve' signal will be driven low to energise the valve when required. Connect the positive lead of the vent valve to '24 V' and the negative lead to 'Vent Valve Control'. The vent valve earth lead must be connected to 'Screen' or a suitable alternative earth point.

#### **CAUTION**

The vent valve output on the logic interface will not be maintained in the event of a power failure. If venting of your turbo pump while it is running at high speed is undesirable, use the vent valve output from the auxiliary terminals. This output will be maintained during a power failure.

**Bakeout band control:** The bakeout band control can be used to switch a relay that can apply power to the band. The relay box has a relay built in for this purpose and provides connectors to allow power to be applied to the bakeout band. Refer to the relay box instruction manual for further information on driving a bakeout band.

To drive a relay without a relay box, connect the coil of a suitable 24 V d.c. relay between 'Bakeout Band Control Output' (negative) and 'Power Supply Positive' (positive).

**Backing pump control:** The backing pump control can be used to switch a relay that can apply power to a mains backing pump. The relay box has a relay built in for this purpose and provides a connector that will switch the pump on and off. Refer to the relay box instructions for further information on driving a backing pump.

To drive a relay without a relay box, connect the coil of a suitable 24 V d.c. relay between 'Backing Pump Output' (negative) and 'Power Supply Positive' (positive).

**Air cooler:** The air cooler output can be used to control the operation of an air cooler. The air cooler signal will be driven low to energise the cooler when required. Connect the positive lead of the cooler to the power supply positive and the negative lead to 'Air Cooler Control'. The air cooler earth lead must be connected to 'Screen' or a suitable alternative earth point.

### 3.3.7.4 Using status outputs

Status outputs provide a means for external systems to react based upon the current state of the TIC.

**Analogue output:** The analogue output provides a 0 V to 10 V signal that can be configured to represent system pressure, pump speed etc. Refer to [Section 4.8](#) for how to configure this output.

To connect this output to an external system, connect the 'Analogue Output Signal' to the positive input of your system and 'Analogue Output Common' to the negative side.

**Relay setpoint:** The setpoint outputs can be used to interface to external logic or can be used to drive relays. Each output can be configured in software to activate at pump speed. Refer to [Section 4.15](#) of the main manual for how to configure these outputs. Each relay can be manually controlled. Refer to [Section 4.5](#).

The relay box has built in relays that can switch external loads and provides a connector to interface to an external system. Refer to the relay box instructions for further information on using the setpoint outputs.

To drive a relay without a relay box, connect the coil of a suitable 24 V d.c. relay between 'Setpoint Output' (negative) and 'Power Supply Positive' (positive).

**Turbo normal speed:** Turbo normal speed can be used to interface to external logic or can be used to drive a relay. This output is normally inactive and will become active when the turbo pump has reached its defined 'Normal' speed.

To drive a relay, connect the coil of a suitable 24 V d.c. relay between 'Turbo Normal Output' (negative) and 'Power Supply Positive' (positive).

**Alarm:** Alarm can be used to interface to external logic or can be used to drive a relay. This output is normally active and will become inactive in the event of an alarm condition.

To drive a relay, connect the coil of a suitable 24 V d.c. relay between 'Alarm Output' (negative) and 'Power Supply Positive' (positive).

### 3.3.8 Connecting the serial interface

The TIC has two serial communications protocols built in, RS232 and RS485. RS232 is the simplest interface and can be used to allow a host PC to control the TIC. RS485 allows a host PC to control a small network of TICs.

#### 3.3.8.1 Connecting RS232

The TIC is fitted with a 9-way 'D' type socket on the rear panel. The interface uses two lines for data transfers and an additional line as a signal common. Hardware handshaking is not implemented.

If connecting to an IBM compatible PC fitted with a 9-way 'D' type socket then a 'straight through' male-female 9-way extension cable can be used to connect the TIC to the computer as shown in [Figure 11](#). Connection to an IBM PC fitted with a 25-way serial connector should be made as shown in [Figure 12](#).

Use shielded cable for the interface to reduce interference problems and limit the length of the RS232 link to less than 10 metres. For longer links, either install line drivers or use RS485.

Figure 11 - IBM PC RS232 interface - 9-way

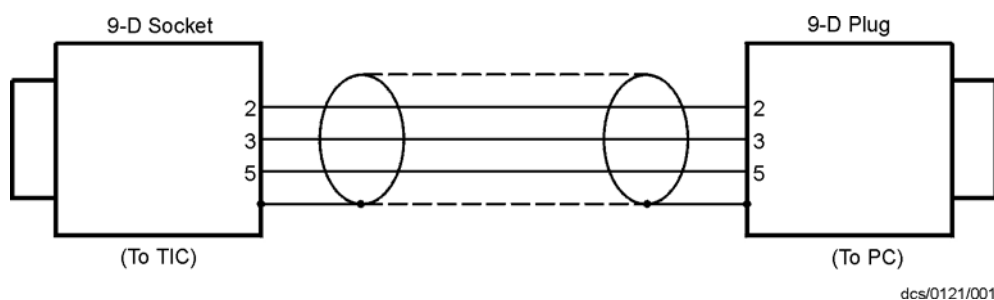

dcsl/0121/001

Figure 12 - IBM PC RS232 interface - 25 way

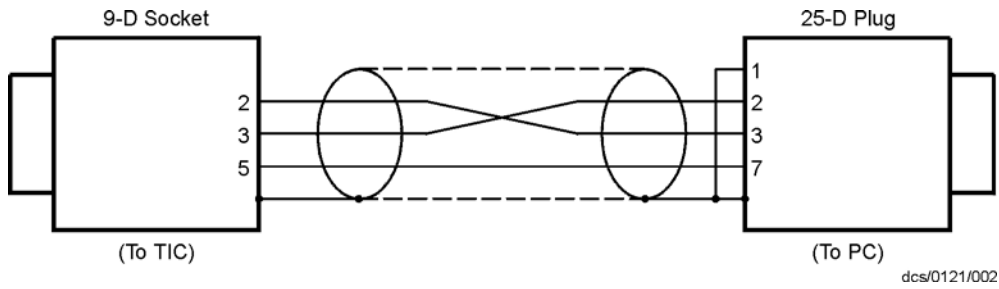

### 3.3.8.2 Connecting RS485

RS485 provides the TIC with the capability to be networked with other TICs and a host PC as shown in Figure 13.

#### CAUTION

All of the ground connections are tied together. If differences exist in the local ground voltage, damage could occur. If the TICs being networked are liable to experience different ground potentials, a suitable RS485 isolator should be connected between them.

Use shielded cable for the interface to reduce interference problems and limit the length of the RS485 link to less than 1000 metres.

Long links may require the addition of 120 Ω terminating resistors at each end of the link to improve communications reliability.

Figure 13 - RS485 TIC network

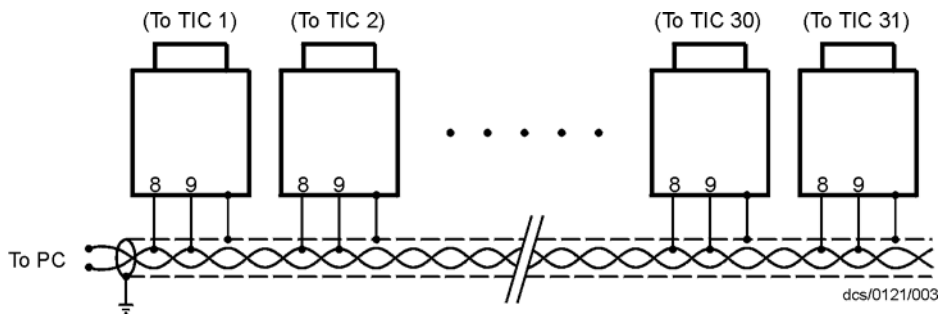

## 4 Operation

### 4.1 Front panel description

Figure 14 - Front panel display

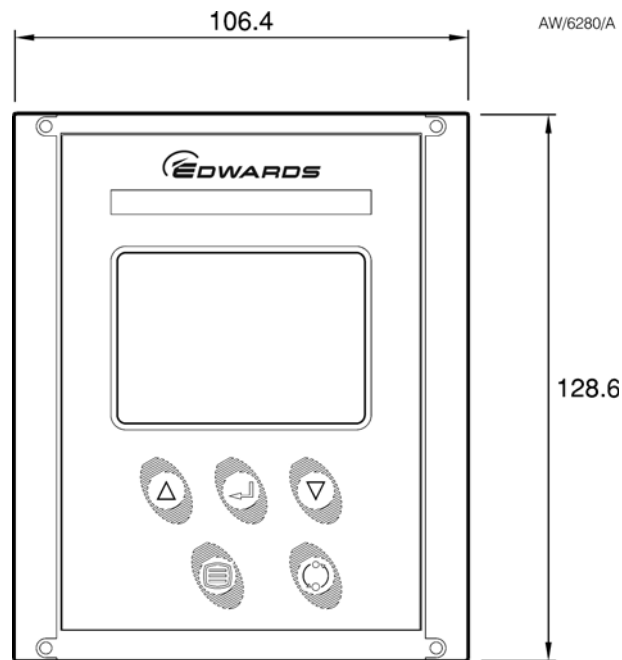







Table 8 - Front panel symbols and their functions

Symbol	Name	Function
	UP	Move up through a menu. Cycle selected numerical values up. Cycle a selected list item upwards.
	DOWN	Move down through a menu. Cycle selected numerical values down. Cycle a selected list item downwards.
	SELECT	Enter the highlighted sub-menu. Edit the highlighted list or numerical item. Move to the next digit of a numerical value. Jump to the setup screen for the highlighted gauge.
	MENU	Switch between the default view screen and the main menu. Exit the current sub-menu or setup screen. Abort edit of a selected list item. Move to the previous digit of a numerical value.
	CYCLE	Turn a highlighted gauge on or off.

## 4.2 Menu structure

Figure 15 and 16 show the view screen shortcuts and menu structure for the TIC. They also give an indication as to what buttons will take you where within the menu layout.

Figure 15 - View screen shortcuts

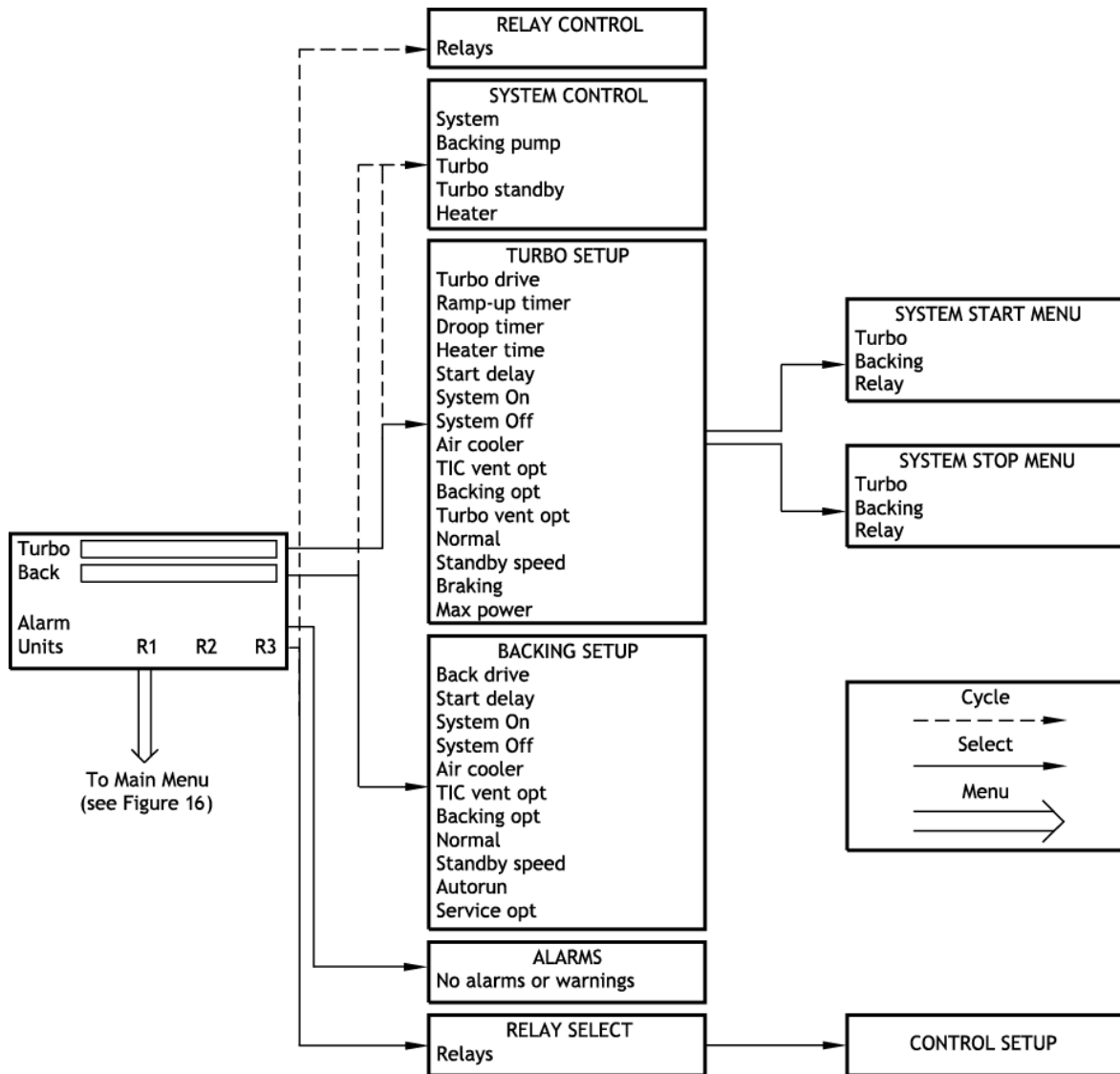

gea/0162/10/12



Figure 16 - Menu structure

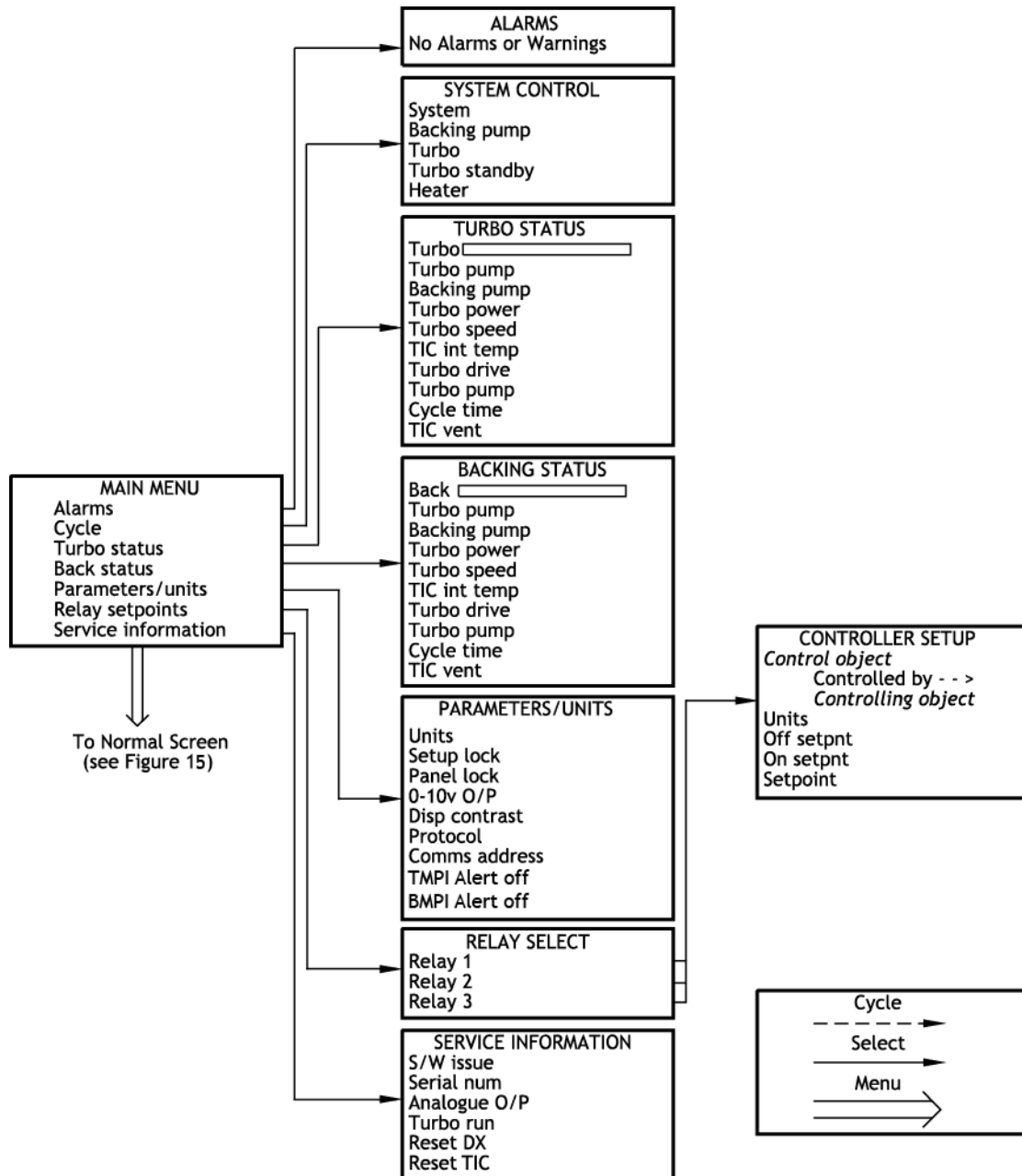

### 4.3 Navigating the menu

This section summarises the display navigation method for the TIC. There are 4 buttons for menu navigation and configuration tasks. A fifth button is used for switching pumps ON and OFF. In most configuration tasks there are no more than three menu levels.

Refer to Table 8 for a description of the functions that the buttons on the front panel perform.

## 4.4 The view screen

The view screen can be set to various view options. The following, describes the view screen that shows 'all'. (Refer to Figure 17).

The top portion of the view screen shows the status of the vacuum pumps; the top line shows the pump speed as a bar chart. In the top right-hand corner the status of the turbo pump is shown as follows:

- Off.           The turbo pump is off.
- >>>.         The turbo pump is accelerating.
- <<<.         The turbo pump is decelerating.
- Run.         The turbo pump is above 50% speed.
- Norm.        The turbo pump is at or above 'normal speed'.
- Strt.         The turbo pump is enabled to start, but will not run until the start delay has run down.
- Flt.         An error has occurred. Select the alarms screen.

The second line provides the basic status of the turbo pump and backing pump under TIC command.

The status of the setpoint relays is shown at the bottom line of the view screen. Relays that are on are shown in reverse video.

Figure 17 - Pump status

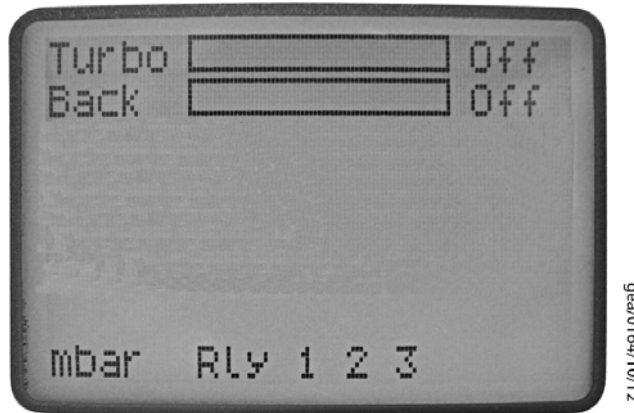

## 4.5 Turning pumps and relays on/off

Pressing the 'Cycle' (○) button whilst the turbo/backing status line is highlighted, a menu of switchable items will appear.

*Note: If SYSI is opened during the vacuum cycle, all connected controllable components will be switched OFF.*

If the selected item is the relay status line, a list of the relays will appear. Scroll to the required relay, use the 'cycle' (○) button to switch the item. When the relay is activated the annunciator on the view screen will change to reverse video.

## 4.6 Changing list items

To change a list item, scroll to the required line and press the 'Select' (↵) button. The list can then be scrolled using the up and down arrows (△/▽).

Pressing the 'Select' (↵) button will accept the adjustment and return the highlight to the row item, allowing another item to be selected for adjustment.

Pressing the 'Menu' (☰) button will cancel the adjustment and return the highlight to the row item, allowing another item to be selected for adjustment.

## 4.7 Changing numerical values

To change a numerical item, scroll to the required line and press the 'Select' (↵) button. The first number will then be highlighted and can be changed using the up and down arrows (△/▽).

The 'Select' (↵) button will move the highlight to the next digit with each successive press, allowing the complete number to be entered. Pressing the 'Select' (↵) button with the last digit selected will accept the adjustment and return the highlight to the row item, allowing another item to be selected for adjustment.

At any time, mistakes can be corrected by pressing the 'Menu' (☰) button. This will move the highlight to the previous digit with each successive button press, allowing corrections to be made. Pressing the 'Menu' (☰) button with the first digit selected will cancel the adjustment and return the highlight to the row item, allowing another item to be selected for adjustment.

Figure 18 - Changing numerical values

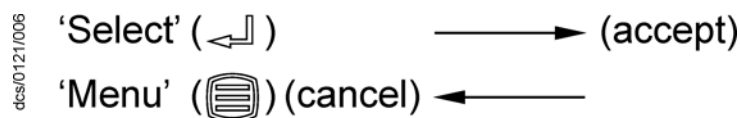

## 4.8 Turbo set up

### CAUTION

All setups in the TIC are held in non-volatile memory. Non-volatile memory has a limit on the number of times its content can be changed. Current minimum lifetime is 100,000 changes on a particular section, this equates to in excess of 1 change per hour every hour for 10 years. If you exceed this number of changes random data may be stored leading to unexpected system behaviour.

### 4.8.1 Introduction

The TIC can be used to configure the EXT, DX and nEXT pump ranges. The menu screen shows differing functionality depending on the pump attached. The TIC will recognise the pump attached, which will be seen on the pump set up and pump status screen. (Refer to Figure 19).

Figure 19 - Turbo set up screen



### 4.8.2 Default turbo set up options

Table 9 - Default turbo setup options

Menu option	Description
Ramp Up Timer	The user can set the ramp up timer from 1 to 30 minutes. This timer will generate an alarm if the pump speed does not rise above 50% speed after the set time.
Droop Timer	The user can set the droop time from 1 to 30 minutes. This timer will generate an alarm if the pump speed drops below 50% speed for longer than the specified time.
Heater time	The user can set the time that the heater band bakes out the turbo pump from 0 to 35 hrs. The heater will come on for the set time, once the pump reaches 'normal speed'. If the pump drops below 'normal speed', the heater band will switch off and the timer will be reset.
Start delay	The start delay enables the user to delay the start of the turbo pump from 0 to 99 minutes.
System ON	Allows the user to define the components of the system that are to be turned on, when the 'system' is cycled on.
System OFF	Allows the user to define the components of the system that are to be turned off, when the 'system' is cycled off.
	<i>Note: The system ON and OFF commands provide manual control of the items listed. Where possible it will override settings such as backing options and gauge linking.</i>
	<i>Note: If the backing pump option has been set to 50% or on stop, 'seq' will be indicated showing the backing pump is sequenced to one of the options.</i>
Air cooler	The user can set when a Edwards air cooler should operate. The air cooler can be set to 'ON' (on permanently) or 'Turbo' (on when the turbo pump is running).
TIC vent options	A vent valve attached to the TIC can be operated in the following ways: 'On stop' to open the vent valve 2 seconds after the stop command, or '50%' to open the vent valve when the pump slows to 50% speed.

**Table 9 - Default turbo setup options (continued)**

Menu option	Description
Backing pump options	<p>A backing pump attached to the TIC or via a relay box can be operated in the following way:</p> <p>None: The backing pump is not sequenced to the Turbo pump</p> <p>50%: The backing pump will turn off after 2 seconds, once the turbo speed has dropped to 50% of its speed. The delay allows detritus to be removed from the system on stop.</p> <p>On stop: The backing pump will turn off 4 seconds after the Turbo off command has been sent. The 4 second delay allows shutting of a valve and then removal of detritus from the system.</p>

Please refer to [Table 10](#) for error and diagnostic information for pumps.

### **CAUTION**

If an Edwards 24 V backing pump is connected, it is advised that the overall power used does not exceed the data specified in [Section 2](#).

**Table 10 - Error/diagnostic monitoring, pumps**

Diagnostic messages	Description
RampUp Timeout	<p>Check whether the pump is too hot or whether the inlet pressure is too high.</p> <p>Check that the backing pump is operational.</p> <p>Check your vacuum system for leaks.</p>
Droop Timeout	<p>Check whether the pump is too hot or whether the inlet pressure is too high.</p> <p>Check that the backing pump is operational.</p> <p>Check your vacuum system for leaks.</p>

### **4.8.3 Additional set up options using a DX or nEXT pump**

The TIC allows the user to set up additional functionality available within a DX, nEXT or nXDS pump.

### **CAUTION**

Read the DX or nEXT pump manual before using the TIC to set up the DX, nEXT or nXDS pump.

Turbo vent options - If a DX, nEXT or nXDS pump is attached, the user can set up one of the Turbo vent options. The user can set up the Turbo vent, and also the TIC vent to enable two vent valves to be connected to a vacuum system. (Refer to [Table 11](#)).

**Table 11 - Turbo pump vent options**

On screen	Description
50%	<p>Vent valve opens fully below 50% full rotational speed for both Stop command or Fail</p> <p><i>Note: This is the default factory setting.</i></p>
50%CvV	<p>Controlled venting from 100% - 50% full rotational speed;</p> <p>Vent valve opens fully below 50% for both Stop command or Fail</p>
STP50%	<p>Vent valve opens fully immediately Stop command is received;</p> <p>Vent valve opens fully below 50% full rotational speed if Fail</p>

Table 11 - Turbo pump vent options (continued)

On screen	Description
STPCnV	Vent valve opens fully immediately Stop command is received; Controlled venting from 100% - 50% full rotational speed then vent valve opens fully below 50% if Fail
FLT50%	Vent valve opens fully immediately if Fail; Vent valve opens fully below 50% full rotational speed if Stop
FLTCnV	Vent valve opens fully immediately if Fail; Controlled venting from 100% - 50% full rotational speed then vent valve opens fully below 50% if Stop command received
STPFLT	Vent valve opens fully immediately for both Stop command or Fail
FLTSTP	Vent valve opens fully immediately for both Stop command or Fail
FAN	Vent is Permanently Enabled, and can be used to provide power to a Edwards air cooler

Table 12 - DX,nEXT and nXDS pump set up options

Menu option	Description
Normal	The TIC allows 'normal speed' to be set as a percentage of full speed.
Standby speed	The user can set the standby speed as a percentage of full speed.
Max power	The user can set the maximum power a DX pump can use.
Braking	Off/Enabled. The user can utilise this function to slow the turbo pump at a quicker rate.
Service opt	nEXT service indication options. Podule flashing LED, fail line, both, none.

Please refer to [Table 13](#) for the error and diagnostic information for DX, nEXT and nXDS pumps.

Table 13 - Error/diagnostic monitoring, DX, nEXT and nXDS pumps

Diagnostic messages	Description
Serial ID Fail	A DX, nEXT, nXDS or serial pump is connected, however the type has not been recognised. Please check the leads are connected.
Turbo Fault	Review the flashing error codes on the pump podule, and refer to the DX, nEXT or nXDS instruction manual.
SC Interlock	Serial enable to the DX, nEXT or nXDS pump was lost while it was running. This could be caused by a temporary loss of power or a broken wire. It is recommended to stop the pump and then restart it. If the alarm does not clear, cycle the controller and then try again.
Uload Timeout	Check that the pump is correctly connected, then try to upload again.
Dload Failed	Check that the pump is correctly connected, then try to download again.
nEXT Service due warning	One of the nEXT items has exceeded its service interval. See nEXT Service screen for details. Contact Edwards for a suitable service kit or to arrange a service by Edwards.
nXDS Service due warning	One of the nXDS items has exceeded its service interval. See nXDS Service screen for details. Contact Edwards for a suitable service kit or to arrange a service by Edwards.

## 4.9 Backing set up

Table 14 - Default Backing set up options

Menu option	Description
Start delay	The start delay enables the user to delay the start of the turbo pump from 0 to 99 minutes.
System ON	Allows the user to define the components of the system that are to be turned on, when the 'system' is cycled on.
System OFF	Allows the user to define the components of the system that are to be turned off, when the 'system' is cycled off.  <i>Note:</i> The system ON and OFF commands provide manual control of the items listed. Where possible it will override settings such as backing options and gauge linking.  <i>Note:</i> If the backing pump option has been set to 50% or on stop, 'seq' will be indicated showing the backing pump is sequenced to one of the options.
Air cooler	The user can set when an Edwards air cooler should operate. The air cooler can be set to 'ON' (on permanently) or 'Turbo' (on when the turbo pump is running).
TIC vent options	A vent valve attached to the TIC can be operated in the following ways: 'On stop' to open the vent valve 2 seconds after the stop command, or '50%' to open the vent valve when the pump slows to 50% speed.
Backing pump options	A backing pump attached to the TIC or via a relay box can be operated in the following way: None: The backing pump is not sequenced to the Turbo pump 50%: The backing pump will turn off after 2 seconds, once the turbo speed has dropped to 50% of its speed. The delay allows detritus to be removed from the system. On stop: The backing pump will turn off 4 seconds after the Turbo off command has been sent. The 4 second delay allows shutting of a valve and then removal of detritus from the system.

Table 15 - nXDS pump set up options

Menu option	Description
Normal	The TIC allows 'normal speed' of the backing pump to be set as a percentage of full speed.
Standby speed	The user can set the standby speed of the backing pump as a percentage of full speed.
Autorun	Sets the nXDS to start when power is turned on
Service opt	nXDS service indication options. Podule flashing LED, fail line, both, none.

## 4.10 Alarms

If an Alarm occurs, an 'Alarms' warning will begin flashing in the lower half of the view screen. Refer to [Figure 17](#).

The Alarm can then be selected by moving the cursor over it and pressing the 'Select' (↵) button. This action will take you to the Alarms screen. Alternatively the Alarms screen can be accessed through the main menu.

The Alarm will stop flashing when it has been acknowledged and will disappear when the alarm situation no longer exists. An alarm is acknowledged by pressing the 'Select' (↵) button whilst the flashing alarm is highlighted.

To clear an alarm you will need to refer to the fault finding guide in [Section 5](#) of this instruction manual. This guide gives information of what the alarm is and the possible solutions for clearing the alarm.

In a similar way a warning can appear. To clear it take the same actions as for alarms above.

## 4.11 The main menu

The main menu can be accessed by pressing the 'Menu' (☰) button on the view screen (refer to Figure 14). From here the following sub-menus can be accessed.

## 4.12 Turbo status

This screen allows the user to view the current status of the Turbo and Backing pumps. Basic information such as:

- Whether the Turbo pump is ON or OFF and a graph of its speed.
- The state of the turbo pump that the user has requested.
- Whether the Backing pump is ON or OFF.
- The power that the Turbo pump is using.
- The speed of the Turbo pump as a percentage of full speed.
- The temperature of the Turbo drive. (Only on DX and nEXT pumps).
- The temperature of the Turbo pump. (Only on DX and nEXT pumps).
- The cycle time is the run time of the current cycle. (Only on DX and nEXT pumps).
- Whether the TIC vent valve is 'on/off'.
- Service menu - enter, press enter to move to the nEXT Service screen.

Table 16 - nEXT Service Screen

nEXT Service	Description
Service due	Indicates which service is due - None, Oil, Bearing, Turbo, Controller. Shows only initial letters if multiple services are due - O B T C.
Oil run	Hours run since last service.
Oil until	Hours left to run until next service.
Bearing run	Hours run since last service.
Bear until	Hours left to run until next service.
Turbo run	Hours run since last service.
Turbo until	Hours left to run until next service.
Contlr run	Stress adjusted hours controller has been powered since last service. Stress adjustment - hours can advance slower or faster than real time depending on temperature and load.
Cntlr until	Stress adjusted hours controller is powered left until next service.
Turbo cycle	Start/stop cycles run since last service.
Cycle until	Start/stop cycles left to run until next service.
Reset Service Due ...	Press enter to move to the nEXT Service Reset screen.

Table 17 - nEXT Service Reset Screen

nEXT Service Reset	Description
Select line below and press enter after servicing	Instructions to follow
Reset oil due	Press enter key to reset only the oil service due
Reset bearing due	Press enter key to reset only the bearing service due



## 4.13 Backing status

This screen allows the user to view the current status of the Turbo and Backing pumps. Basic information such as:

- Whether the Backing pump is ON or OFF and a graph of its speed.
- The state of the turbo pump that the user has requested.
- Whether the Backing pump is ON or OFF.
- The power that the Backing pump is using.
- The speed of the Backing pump as a percentage of full speed.
- The temperature of the Backing drive. (Only on nXDS pumps).
- The cycle time is the run time of the current cycle. (Only on nXDS pumps).
- Whether the TIC vent valve is 'on/off'.
- Service menu - enter, press enter to move to the nXDS Service screen.

Table 18 - nXDS Service Screen

nXDS Service	Description
Service due	Indicates which service is due - None, Tip Seal, Bearing, Backing, Controller. Shows only initial letters if multiple services are due - O B T C.
TipSeal run	Hours run since last service.
TipSeal til	Hours left to run until next service.
Bearing run	Hours run since last service.
Bear until	Hours left to run until next service.
Back run	Hours run since last service.
Cntrlr run	Stress adjusted hours controller has been powered since last service. Stress adjustment - hours can advance slower or faster than real time depending on temperature and load.
Back cycle	Start/stop cycles run since last service.
Reset Service Due	... Press enter to move to the nXDS Service Reset screen.

Table 19 - nXDS Service Reset Screen

nXDS Service Reset	Description
Select line below and press enter after servicing	Instructions to follow
Reset Tip Seal due	Press enter key to reset only the oil service due
Reset bearing due	Press enter key to reset only the bearing service due

## 4.14 Parameters/units

This screen allows the user to change the units that are displayed and other parameters such as:

- Setup lock - When the 3 digit lock code is entered, the lock is enabled and an operator will not be able to change any of the setups, however the operator is still able to scroll through the menus and start and stop pumps. The lock is disabled by entering the 3 digit unlock code. Lock - 501, unlock - 147.
- Panel Lock - This function completely locks the front panel. An operator will only be able to see the view screen. Lock - 509, unlock - 824.
- The 0 - 10 V analogue output on the logic interface can be set to follow the turbo speed.
- Display contrast allows the user to change the contrast of the display.
- Protocol shows whether RS232 or RS485 is being used.
- Comms address - To set the comms address of the TIC.
- TMPI Alert off - To disable/enable the warning when using TMPI line to start the Turbo pump.
- BMPI Alert off - To disable/enable the warning when using BMPI line to start the Backing pump.

## 4.15 Relay setpoint outputs

The relay setpoints option allows the setpoint outputs on the logic interface to be linked to turbo speed. When selected, a summary of the current setting is displayed. The default setting for the three relays is 'Not Linked'.

There are four steps to set up the links, proceed as follows:

Select the controlled relay. Scroll to the relay that is to be controlled and press the 'Select' (↵) button.

Select the controlling item. The top highlighted line is used to select the controlling item. The controlling item can either be 'Not Linked' or 'Turbo Speed' (%). Press the 'Select' (↵) button to confirm the choice.

Enter the required setpoint. The 'On' and 'Off' setpoints can be adjusted to suit the application. For pumps, the unit used is 'Turbo Speed' (%).

**Note:** For pumps, the 'Off' setpoint is less than or equal to the 'On' setpoint.

Enable the set point. Once configured, the setpoint should be enabled by changing the bottom 'Setpoint' line from 'OFF' to 'ENABLED'.

## 4.16 Service information

Service information contains the following information:

- Software Issue - This is the issue of the currently installed software. This will change when new software is downloaded to the TIC in the future.
- Serial Number - The serial number of the TIC is used when contacting Edwards about the product.
- Analogue O/P - The analogue output value (internal units) is used when contacting Edwards about the product.
- PSU Temp - Temperature of PSU.
- TIC Temp - Temperature of TIC.
- Turbo run - Number of hours the turbo pump has been run (DX and nEXT pumps only).
- Upload Turbo - The TIC can store one set of the pump's configuration. This function will upload the current configuration from the attached pump (DX and nEXT pump only).
- Download Turbo - The TIC can download one set of configurations to DX and nEXT pumps, once a configuration has been uploaded. This function will download the stored configuration to the attached pump (DX and nEXT pump only).
- Reset Trbo - Reset the turbo pump to it's factory defaults (DX and nEXT pumps only).
- Reset TIC - Resets the TIC to it's factory default configuration and can be used to quickly undo all user settings (relay setpoints, units, etc.).

## 4.17 Electrical supply failure

If the electrical supply to the controller fails while the turbo pump is rotating at high speed, the pump begins acting like a generator and will supply power back to the TIC. This power will be used to maintain operation of the vent valve, and if enough power is available the TIC will maintain operation.

The power returned to the TIC is not made available to the logic interface or the air cooler; all of these will stop operating until power is restored.

Once the turbo pump speed falls below 50%, the vent valve will open and the TIC will shut down.

This page has been intentionally left blank.

## 5 Maintenance

### 5.1 Safety



#### WARNING

Obey the safety instructions given below and take note of the appropriate precautions. If you do not, you could cause injury to people or damage to equipment.

There are no serviceable parts on the TIC. Do not open, return to your nearest Edwards service centre for any repairs that are necessary.

The Edwards return of equipment forms can be found at the rear of this manual.

### 5.2 Fault finding

Table 20 - Fault finding

	Diagnostic messages	Description
Pump	RampUp Timeout	Refer to Table 10
	Droop Timeout	Refer to Table 10
DX and nEXT	Serial ID Fail	Refer to Table 13
	Turbo Fault	Refer to Table 13
	SC Interlock	Refer to Table 13
	Uload Timeout	Refer to Table 13
	Dload Failed	Refer to Table 13
	nEXT Service Due	Refer to Table 13
General	SYSI Inhibit	The system interlock has been disconnected. Please check that the logic interface plug is connected correctly, or check the status of the system interlocks.
	Ext Inhibit	Enable lines have been disconnected, please check the Turbo or Backing pump enable lines.
	No Reading	An object has not received a value update from its source within a given time and is flagging that its value is now old. Check connections to components of system.
	No Message	An object has not received a reply to a message it sent within a given time. Check logic interface connections, are correctly attached to the TIC.
	Brownout/Short	Either the loading on the TIC outputs exceeds a certain current level or there was a brownout of the mains power while a turbo was spinning and could provide some regen power. Remove the short or high load and then accept the error, the TIC will re-attempt to drive the output. If a brownout wait for it to pass and then accept the error.

### 5.3 Cleaning the controller

If necessary, use a soft dry cloth to clean the exterior of the Controller. Do not clean with harsh abrasives or liquids.

If the interior of the Controller requires cleaning, it is our recommendation that you return the Controller to your supplier or your nearest Edwards Service Centre.

## 5.4 Software updates

The software within the Controller and the TIC PC monitor program will be updated as part of Edwards ongoing development program. The updates and associated instruction manual can be found by visiting [www.upgrades.edwardsvacuum.com](http://www.upgrades.edwardsvacuum.com).

## 5.5 Factory defaults

The following is a list of factory default settings for the TIC:

Table 21 - Factory default settings

Menu option	Default
Pump and relay slaving	- not slaved
Turbo pump start delay	= 0
EXDC Ramp time	= 8
EXDC Droop time	= 8
Analogue out slaved	= NONE
TIC vent	= 50%
Heater band	= 0 hrs
Air Cooler	= Turbo
Setup lock	= Off
Panel lock	= Off
Display contrast	= 5
PC comms	= RS232
Multi-drop address	= 0
Default screen	= All
System On	= Backing
System Off	= Turbo
Backing option	= None

## 6 Storage and disposal

### 6.1 Storage

Store the Controller in clean dry conditions in accordance with the technical specifications. Refer to [Section 6](#) of the main manual on CD.

### 6.2 Disposal

Dispose of the Controller and any components safely in accordance with all-local and national safety and environmental requirements.

Alternatively, you may be able to recycle the Controller and/or cables; contact Edwards or your supplier for advice (also see below).

The Controller and associated cables are within the scope of the European Directive on Waste Electrical and Electronic Equipment, 2002/96/EC. Edwards offer European customers a recycling service for the Controller/cables at the end of the product's life. Contact Edwards for advice on how to return the Controller/cables for recycling.



#### **WARNING**

Do not incinerate the Controller. If the Controller is heated to very high temperatures, dangerous gases may be emitted and internal components may explode.

This page has been intentionally left blank.



## 7 Service, spares and accessories

### 7.1 Service

A worldwide network of Edwards Service Centres supports Edward's products. Each Service Centre offers a wide range of options including equipment decontamination; service exchange; repair; rebuild and testing to factory specifications. Equipment, which has been serviced, repaired or rebuilt, is returned with a full warranty.

For more information about service options, contact your nearest Service Centre or other Edwards company.

### 7.2 Spares

Spare	Item Number
TIC Front Bezel Kit	D397-00-803
TIC Logic Interface	D397-00-850
Front Panel Assembly	D397-00-822

*Note: This assembly is suitable for customers who have electrical and electronic repair expertise and possess a portable appliance tester. If the customer is unable to carry out this repair, the Controller should be returned to Edwards for a full repair and safety re-test.*

### 7.3 Accessories

Table 22 shows the range of accessories that can be purchased.

Table 22 - Accessories

Product Description	Ordering Information
<b>TIC Controllers</b> TIC Profibus Module	D397-50-000
<b>Turbo Pumps and Controllers</b> EXT70H range (EXDC80 Control Module required with above Turbo Pumps) EXT255H range (EXDC160 Control Module required with above Turbo Pumps) EXT75DX range EXT255DX range nEXT range	D396-45-000  D396-46-000
<b>Extension Cables DX/EXDC and 24 V backing pumps</b> 1 m DX/EXDC extension cable (16/0.2) 3 m DX/EXDC extension cable (16/0.2) 5 m DX/EXDC extension cable (16/0.2)	D397-00-835 D397-00-836 D397-00-837
<b>Air Cooler</b> ACX70 ACX250	B580-53-050 B580-53-150

Table 22 - Accessories (continued)

Product Description	Ordering Information
<b>Vent Valves</b> TAV5 TAV6	B580-66-010 B580-66-020
<b>Examples of compatible 24 V backing pumps</b> XDD1 24 V d.c. Diaphragm pump	A746-01-991
<b>Examples of compatible mains backing pumps</b> XDS10 220-240 V 50 Hz 1-phase XDS10 115-120 V 60 Hz 1-phase E2M1.5 220-240 V 50/60 Hz 1-phase E2M1.5 115-120 V 50/60 Hz 1-phase RV12 110-120 V 60 Hz or 220-240 V 50 Hz 1-phase E2M28 220-240 V 50 Hz or 230-240 V 60 Hz 1-phase E2M28 115/230 V 60 Hz 1-phase	A726-01-903 A726-01-906 A371-22-919 A371-22-902 A655-01-903 A373-15-903 A373-15-981
<b>Bakeout band (via optional relay box)</b> BX70 240 V 30 W (EXT70H & EXT75DX) BX70 110 V 30 W (EXT70H & EXT75DX) BX250 240 V 60 W (EXT255H) BX250 110 V 60 W (EXT255H)	B580-52-060 B580-52-040 B580-52-061 B580-52-041
<b>24 V backing line valves (via optional relay box)</b> LCPV16EKA 24 V a.c./d.c. LCPV25EKA 24 V a.c./d.c.	C417-51-200 C417-52-200
<b>Relay Boxes</b> TIC Relay box 3 x 240 V 3 A TIC Relay box TIC Relay box comb	D397-00-804 D397-11-805 D397-21-806
<b>Interface cables</b> 2 m Logic interface cable 2 m RS232 interface cable	D397-00-833 D397-00-834
<b>Mains cables (Suitable for TIC controllers)</b> 2 m UK plug 2 m USA plug 2 m Northern European plug	D400-13-025 D400-13-120 D400-13-120
<b>Other accessories and supporting products</b> TIC software upgrade	<a href="http://www.upgrades.edwardsvacuum.com">www.upgrades.edwardsvacuum.com</a>

# Index

## A

Accessories .....	35
Additional earth bonding .....	12
Additional set up options using a DX or nEXT pump .....	23
Auxiliary terminals .....	6

## B

Backing pump connector .....	5
Backing set up .....	25

## C

Changing list items .....	21
Changing numerical values .....	21
Cleaning the controller .....	31
Connecting a backing pump .....	13
Connecting a turbo pump .....	13
Connecting a vent valve .....	13
Connecting an air cooler .....	13
Connecting RS232 .....	15
Connecting RS485 .....	16
Connecting the electrical supply .....	12
Connecting the logic interface .....	13
Connecting the serial interface .....	15
Connections .....	4
Controller electrical connections .....	12

## D

Default pump set up options .....	22
Disposal .....	33

## E

Electrical data .....	3
Electrical supply failure .....	29

## F

Factory defaults .....	32
Fault finding .....	31
Fitting the controller .....	9
Front panel description .....	17

## I

Installation .....	9
Introduction .....	1, 13, 21

## L

Logic interface .....	7
-----------------------	---

## M

Maintenance .....	31
Mechanical data .....	3
Menu structure .....	18

## N

Navigating the menu .....	19
---------------------------	----

## O

Operating and storage data .....	3
Operation .....	17

## P

Parameters/units .....	27
Product description .....	1
Pump set up .....	21
Pump status .....	26

## R

Relay setpoint outputs .....	28
------------------------------	----

## S

Safety .....	31
Scope and definitions .....	1
Serial communications .....	8
Service .....	35
Service information .....	29
Service, spares and accessories .....	35
Software updates .....	32
Spares .....	35
Storage .....	33
Storage and disposal .....	33

## T

Technical data .....	3
The main menu .....	26
The view screen .....	20
Turbo pump connector .....	4
Turning pumps and relays on/off .....	21

## U

Unpack and inspect .....	9
Using control inputs .....	14
Using control outputs .....	14
Using status outputs .....	15

This page has been intentionally left blank.