

# Instruction Manual

## TIC Instrument Controller 6-Gauge



Description	Item Number
TIC Instrument Controller 6-Gauge	D397-01-000
TIC Instrument Controller 6-Gauge Capacitance Manometer	D397-02-000





# Declaration of Conformity

We, Edwards Limited,  
Crawley Business Quarter,  
Manor Royal,  
Crawley,  
West Sussex RH10 9LW, UK

declare under our sole responsibility, as manufacturer and person within the EU authorised to assemble the technical file, that the product(s)

TIC Instrument Controller	D397-00-000
TIC Instrument Controller 6-Gauge	D397-01-000
TIC Instrument Controller 6-Gauge Capacitance Manometer	D397-02-000
TIC Turbo Controller 100W	D397-11-000
TIC Turbo Controller 200W	D397-12-000
TIC Turbo & Instrument Controller 100W	D397-21-000
TIC Turbo & Instrument Controller 200W	D397-22-000

to which this declaration relates is in conformity with the following standard(s) or other normative document(s)

EN61010-1:2010	Safety Requirements for Electrical Equipment for Measurement, Control and Laboratory Use - Part 1: General Requirements.
EN61326-1:2006 (Industrial location, Class B Emissions)	Electrical Equipment for Measurement Control and Laboratory Use - EMC Requirements.
CAN/CSA-C22.2 No.61010-1-04	Safety requirements for electrical equipment for measurement, Control and laboratory use - Part 1: General requirements
UL61010-1, 2 <sup>nd</sup> Edition	Safety requirements for electrical equipment for measurement, Control and laboratory use - Part 1: General requirements

and fulfils all the relevant provisions of

2006/95/EC	Low Voltage Directive.
2004/108/EC	Electromagnetic Compatibility Directive.
2012/19/EU	Waste from Electrical and Electronic Equipment (WEEE) Directive

*Note: This declaration covers all product serial numbers from the date this Declaration was signed onwards.*

*L G Marini*

17/10/2013, Eastbourne

Mr L Marini, Senior Technical Manager

Date and Place

This product has been manufactured under a quality system certified to ISO9001:2008

# Contents

Section	Page
<b>1</b>	<b>Introduction</b> ..... 1
1.1	Scope and definitions ..... 1
1.2	Product description ..... 1
<b>2</b>	<b>Technical data</b> ..... 3
2.1	Electrical data ..... 3
2.2	Operating and storage data ..... 3
2.3	Mechanical data ..... 3
2.4	Connections ..... 3
2.4.1	Active gauge connectors ..... 3
2.4.2	Logic interface ..... 4
2.4.3	Serial communications ..... 6
2.4.4	Analogue outputs ..... 7
<b>3</b>	<b>Installation</b> ..... 9
3.1	Unpack and inspect ..... 9
3.2	Fitting the controller ..... 9
3.3	Controller electrical connections ..... 12
3.3.1	Connecting the electrical supply ..... 13
3.3.2	Additional earth bonding ..... 13
3.3.3	Connecting an active gauge ..... 13
3.3.4	Connecting the logic interface ..... 14
3.3.5	Connecting the serial interface ..... 15
<b>4</b>	<b>Operation</b> ..... 17
4.1	Front panel description ..... 17
4.2	Menu structure ..... 18
4.3	Navigating the menu ..... 19
4.4	The view screen ..... 20
4.5	Turning gauges and relays ON/OFF ..... 20
4.6	Changing list items ..... 21
4.7	Changing numerical values ..... 21
4.7.1	Entering negative components e.g. 5.00E-03 ..... 21
4.8	Gauge setup ..... 22
4.8.1	Default setup options (all gauges) ..... 22
4.8.2	Gauge status messages ..... 23
4.8.3	Active Pirani Gauge (APG) ..... 23
4.8.4	Active Linear Pirani Gauge (APGX) ..... 24
4.8.5	Active Thermocouple Gauge (ATC-E) control ..... 25
4.8.6	Active Strain Gauge (ASG) control ..... 26
4.8.7	Active Inverted Magnetron (AIM) Gauge control ..... 27
4.8.8	Active Ion Gauge (AIGX-S) control ..... 28
4.8.9	Wide Range Gauge (WRG) ..... 29
4.8.10	Ion Gauge Controller (IGC) - gauge type displayed as 'IONEB' ..... 31
4.8.11	Capacitance Manometer Gauges (D39702000 only) ..... 33
4.9	Alarms ..... 34
4.10	The main menu ..... 34
4.11	Linking gauges ..... 34
4.12	Parameters/Units ..... 35
4.13	Screen options ..... 36
4.13.1	Organising gauges on the view screen ..... 36

4.14	Relay setpoint outputs .....	37
4.15	Service information .....	37
4.16	Electrical supply failure .....	37
<b>5</b>	<b>Maintenance .....</b>	<b>39</b>
5.1	Safety .....	39
5.2	Fault finding .....	39
5.3	Cleaning the controller .....	40
5.4	Software updates .....	40
5.5	Factory defaults .....	40
<b>6</b>	<b>Storage and disposal .....</b>	<b>41</b>
6.1	Storage .....	41
6.2	Disposal .....	41
<b>7</b>	<b>Service, spares and accessories .....</b>	<b>43</b>
7.1	Service .....	43
7.2	Spares .....	43
7.3	Accessories .....	43
	<b>Index .....</b>	<b>45</b>

For return of equipment, complete the HS Forms at the end of this manual.

## Illustrations

Figure		Page
1	Pin connections for an 8-way FCC/RJ45 .....	4
2	Pin connections for a 15-way sub-miniature 'D' type socket .....	4
3	Pin connections for a 9-way sub-miniature 'D' type socket .....	6
4	Pin connection for 4-way analogue output connector .....	7
5	Bench mounted TIC dimensions (mm) .....	10
6	Front panel removal .....	11
7	Rack mounting of a TIC .....	11
8	Panel cut out drawing .....	12
9	Rear panel connections .....	12
10	IBM PC RS232 interface - 9-way .....	15
11	IBM PC RS232 interface - 25-way .....	16
12	RS485 TIC network .....	16
13	Front panel display .....	17
14	View screen shortcuts .....	18
15	Menu structure .....	19
16	New gauge connected .....	20
17	Changing numerical values .....	21
18	Gauge setup screen .....	22
19	Gauge setup screen APGX-M .....	24
20	Gauge setup screen ASG .....	26
21	Gauge setup screen AIGX .....	28
22	Gauge setup screen WRG .....	30
23	Setup screen IGC .....	32
24	Setup screen Capacitance Manometer .....	34
25	Controlled item .....	35
26	Control setup .....	35
27	Gauge order set up .....	36

## Tables

Table	Page
1	Compatible equipment for the TIC Instrument Controller 6-Gauge ..... 2
2	Gauge connector pin-out ..... 4
3	Logic interface connector pin-out ..... 5
4	Serial communications connector pin-out ..... 6
5	Pin allocation for analogue outputs ..... 7
6	Component checklist ..... 9
7	Capacitance Manometer gauges ..... 13
8	Other gauges ..... 13
9	Logic connector Edwards accessories ..... 14
10	Front panel symbols and their functions ..... 17
11	Default setup options (all gauges) ..... 22
12	Gauge status messages ..... 23
13	Error/diagnostic monitoring APG ..... 23
14	Setup options APGX ..... 24
15	Error/diagnostic monitoring APGX ..... 25
16	ATC-D and ATC-M gauge tubes ..... 25
17	Error/diagnostic monitoring ATC-E ..... 26
18	Setup options ASG ..... 26
19	Error diagnostic monitoring ASG ..... 27
20	Error/diagnostic monitoring AIM ..... 27
21	Setup options AIGX ..... 28
22	Error/diagnostic monitoring AIGX ..... 29
23	Setup options WRG ..... 29
24	Error/diagnostic monitoring WRG ..... 30
25	Setup options IGC ..... 31
26	Diagnostic messages ..... 32
27	Setup options Capacitance Manometer ..... 33
28	Fault finding ..... 39
29	Factory default settings ..... 40
30	Accessories ..... 43

## Trademark credits

Barocel® is a registered trademark of TBA

This page has been intentionally left blank.

# 1 Introduction

## 1.1 Scope and definitions

This manual provides Installation, Operation and Maintenance instructions for the Edwards TIC Instrument Controller 6-Gauge. You must use the Controller as specified in this manual.

Read this manual before you install and operate the Edwards TIC Instrument Controller 6-Gauge. Important safety information is highlighted as WARNING and CAUTION instructions; you must obey these instructions. The use of WARNINGS and CAUTIONS is defined below.



### **WARNING**

Warnings are given where failure to observe the instruction could result in injury or death to people.

---

### **CAUTION**

Cautions are given where failure to observe the instruction could result in damage to the equipment, associated equipment and process.

---

Throughout this manual, page, figure or table numbers are sequential.

The following IEC warning label appears on the controller:



Warning - refer to accompanying documentation.



Edwards offer European customers a recycling service.

## 1.2 Product description



### **WARNING**

Improper use of the equipment could cause damage to it or injury to people. The user is responsible for the safe operation and monitoring of the equipment. Hazardous voltages should not be connected to this unit except where specified.

---

The TIC Instrument Controller 6-Gauge is provided with a large clear graphics display, easy-to-use control interface via a keypad, an RS232/485 interface for control and data monitoring on a remote PC and a logic interface for interface with associated system hardware.

The compatible instruments that can be used with the TIC Instrument Controller 6-Gauge are listed in [Table 1](#).

Table 1 - Compatible equipment for the TIC Instrument Controller 6-Gauge

TIC variant	Compatibility
TIC Instrument Controller 6-Gauge	Up to 6 active gauges including: APG, APGX, ATC, ASG, AIM, WRG, AIGX and IGC
TIC Instrument Controller 6-Gauge Capacitance Manometer	Up to 6 active gauges including: APG, APGX, ATC, ASG, AIM, WRG, AIGX, IGC and Capacitance Manometers 600, 622, 655 and 658



## 2 Technical data

### 2.1 Electrical data

Connector type	CEE/IEC 320
Electrical supply	90 to 264 V a.c. 47 to 63 Hz
Power consumption	160 VA maximum (rated power consumption is based upon maximum specified load)
Fuse	The unit is self-protecting and has no user replaceable fuse. The unit will recover once any overload is removed.
Earth Stud	M4

### 2.2 Operating and storage data

Ambient operating temperature range	0 °C to 40 °C (measured underneath TIC)
Ambient storage temperature range	-30 °C to 70 °C
Maximum ambient operating humidity	Max 90% RH non condensing at 40 °C
Maximum operating altitude	3000 m max
IP rating	20
IEC rated pollution degree	2

### 2.3 Mechanical data

Weight	1.7 kg
--------	--------

### 2.4 Connections

#### 2.4.1 Active gauge connectors

Connector type	FCC/RJ45, 8-way (refer to <a href="#">Figure 1</a> )	
Maximum power rating	See <a href="#">Section 3.3</a>	
Input voltage range	-0.3 V to 13 V	
Output ID current	33 $\mu$ A, 0 V to 13 V	
Control output	active:	<0.8 V d.c. (2 mA max)
	inactive:	open (internal pull-up to 24 V)
Control input	low:	<2.0 V d.c. ( $I_{out}$ <160 $\mu$ A)
	high:	>3.5 V d.c. (internally pulled up to 24 V)

Figure 1 - Pin connections for an 8-way FCC/RJ45

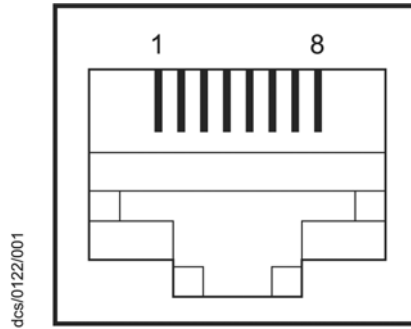

Table 2 - Gauge connector pin-out

Pin	Allocation
1	Power supply positive
2	Power supply common
3	Signal input
4	Identification
5	Signal common
6	Control line 1
7	Control line 2
8	Power supply negative for Capacitance Manometer N/C for all other versions

### 2.4.2 Logic interface

Connector type	25-way sub-miniature 'D' type socket (refer to Figure 2)
Power supply	24 V d.c.
Maximum output power	See Section 3.3
Control output	active: <math><1.1\text{ V d.c. (I}_{out} < 20\text{ mA}</math> <math><0.8\text{ V d.c. (I}_{out} < 2\text{ mA}</math>
	inactive: open (internal pull up to 24 V)
Control input	low: <math><2.0\text{ V d.c. (I}_{out} < 160\text{ }\mu\text{A}</math>
	high: 3.5 V to 24 V d.c. (internal pull up to 24 V)
Analogue output	0 to 10 V (5 mA max) 50 mV resolution

Figure 2 - Pin connections for a 15-way sub-miniature 'D' type socket

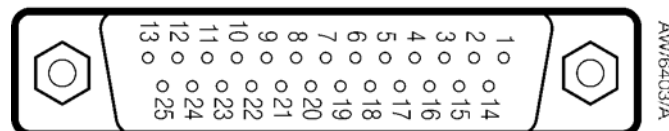

Table 3 - Logic interface connector pin-out

Pin	Allocation
1	Screen
2	Analogue output signal
3	Setpoint 1 output
4	Do not connect
5	Setpoint 5 output
6	Setpoint 4 output
7	Power supply common
8	Do not connect
9	Gauge 1 enable input
10	Power supply common
11	Power supply positive
12	Power supply common
13	Power supply common
14	Analogue output common
15	Setpoint 2 output
16	Setpoint 3 output
17	Do not connect
18	Alarm output
19	Setpoint 6 output
20	Gauge 2 enable input
21	Gauge 3 enable input
22	Do not connect
23	Do not connect
24	Do not connect
25	System interlock input (SYSI)

2.4.3 Serial communications

Connector type	9-way sub-miniature 'D' type socket (refer to Figure 3)	
RS232 transmit	mark:	< - 8 V ( $I_{out}$ max: -8 mA)
	space:	> +8 V ( $I_{out}$ max: +8 mA)
RS232 receive	mark:	< +1.0 V ( $I_{in}$ max: -2.0 mA)
	space:	>+2.0 V ( $I_{in}$ max: +2.0 mA)
	maximum input:	$\pm 12$ V
RS232 protocol	9600 baud, 1 stop bit, 8 data bits, no parity	
RS485	Output differential:	>1.5 V ( $I_{out}$ max: $\pm 25$ mA)
	Input differential threshold:	$\geq 0.2$ V ( $I_{in}$ max: $\pm 1$ mA)
	Maximum input:	-7.0 V to +12 V
Bus load	The TIC applies one unit load to the RS485 bus.	

Figure 3 - Pin connections for a 9-way sub-miniature 'D' type socket

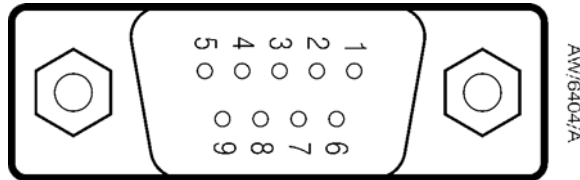

Table 4 - Serial communications connector pin-out

Pin	Allocation
1	N/C
2	RS232 transmit
3	RS232 receive
4	N/C
5	RS232 common
6	N/C
7	N/C
8	RS485 data A
9	RS485 data B

### 2.4.4 Analogue outputs

Connector type	Phoenix 2.5 mm 4-way mating half Phoenix FK-MC 0.5/4-ST-2.5 (available from Edwards as 5000 17005)
Short circuit protection	All signals
Max load	Gauge signals: $\pm 1$ mA Common: $\pm 3$ mA
Output voltages	
Gauge connected:	Gauge signal voltage ( $\pm 2\% \pm 15$ mv when in range 0 to +10 V)
Gauge disconnected:	12 V ( $\pm 1.3$ V)

Figure 4 - Pin connection for 4-way analogue output connector

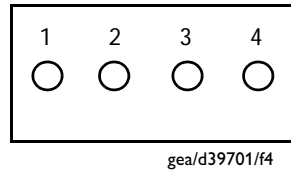

Table 5 - Pin allocation for analogue outputs

Pin	Allocation	
	Gauges 1-3 (Top Ports)	Gauges 4-6 (Lower Ports)
1	Gauge 1 signal	Gauge 4 signal
2	Gauge 2 signal	Gauge 5 signal
3	Gauge 3 signal	Gauge 6 signal
4	Common (0 V)	Common (0 V)

This page has been intentionally left blank.

## 3 Installation

### 3.1 Unpack and inspect

Remove all of the packaging material and check the Controller. If the Controller is damaged, follow the Edwards return of equipment procedures that are laid out in the back of this manual. Do not use the Controller if it is damaged.

Check that your package contains the items that are listed in [Table 6](#). If any of these items are missing, notify your supplier in writing within three days. If the Controller is not to be used immediately, store the Controller in suitable conditions as described in [Section 6.1](#).

Table 6 - Component checklist

Quantity	Description	Check (✓)
1	Controller	<input type="checkbox"/>
1	Quick Guide and Health and Safety Information	<input type="checkbox"/>
1	TIC CD	<input type="checkbox"/>
2	Rear non-slip feet	<input type="checkbox"/>
1	Logic interface plug	<input type="checkbox"/>
2	Analogue output mating half connectors	<input type="checkbox"/>

### 3.2 Fitting the controller



#### **WARNING**

If access to the IEC connector is restricted an additional isolation device should be provided, which will be easily accessible by an operator.

#### **CAUTION**

Rubber feet must be fitted ([Figure 5](#), item 1) so that there are correct clearances for air circulation. If you do not, the performance of the Controller may be affected at high operating temperatures.

The Controller can be used on a bench-top or can be fitted in a rack or cabinet. [Figure 5](#) shows the dimensions of the TIC that are required for bench top use.

*Note:* If the interlocks are not used the logic interface adaptor must be fitted to the 25-way connector.

Figure 5 - Bench mounted TIC dimensions (mm)

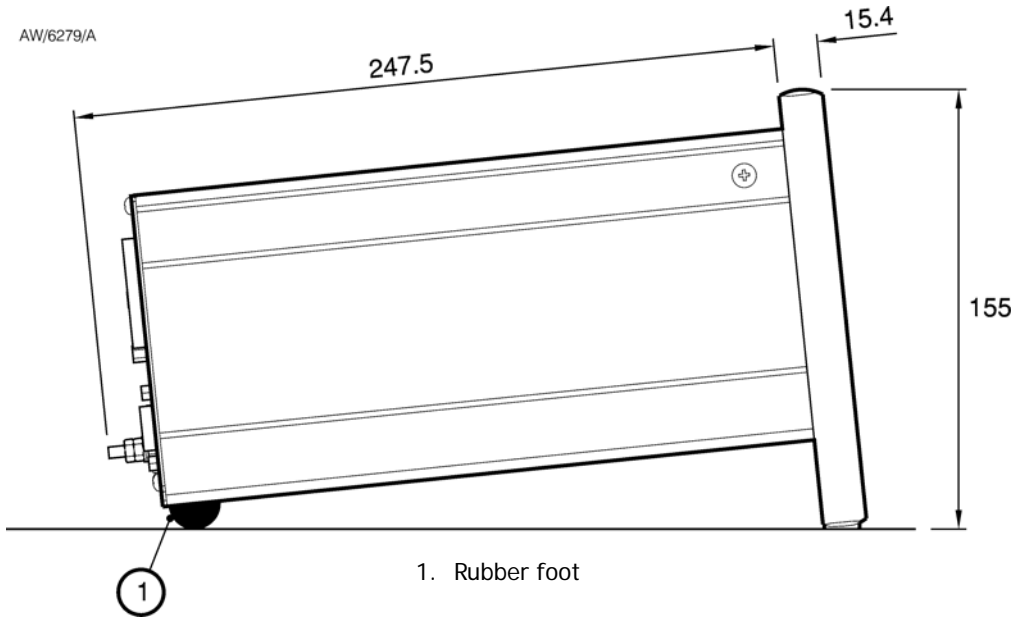

**WARNING**

Ensure that all electrical wiring is safely secured so that people cannot trip on them.

If a Controller is fitted in a rack, cabinet or panel, follow the directions given in Figure 6, 7 and 8.

**CAUTION**

Allow 150 mm at the rear for cables. Allow 50 mm top and bottom and 15 mm to the sides for sufficient air circulation. Do not cover any of the ventilation holes.

**CAUTION**

This unit is IP20 rated. Please ensure that the unit is not installed where fluids can enter into the controller.

**CAUTION**

The unit must be supported at the rear.



Figure 6 - Front panel removal

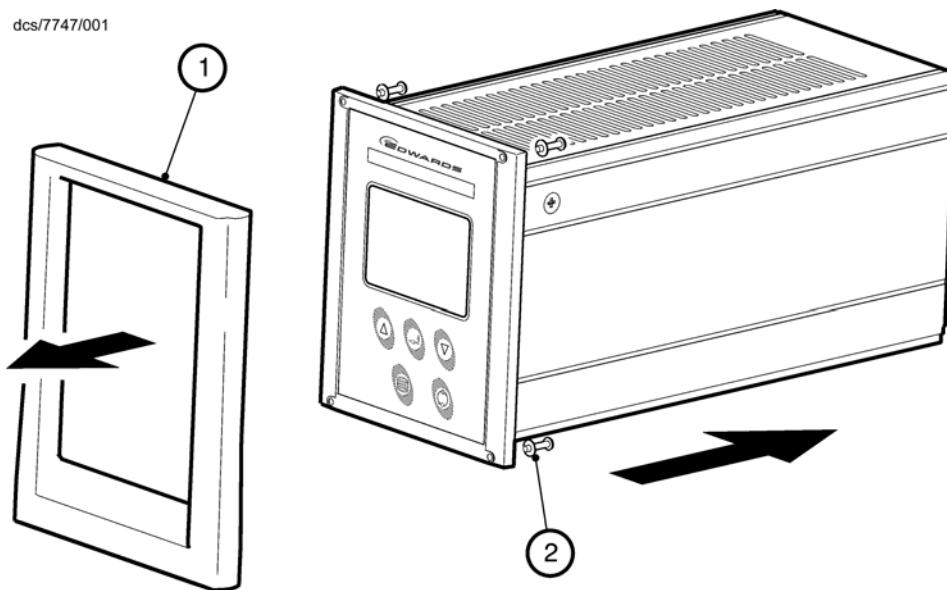

1. Bench top adaptor
2. Fixing screw and washer

- Remove the bench top adaptor (Figure 6, item 1) by removing the four screws (Figure 6, item 2).
- Slide the Controller into the 19" rack or panel cut out. The use of 19" rack guide rails (Figure 7, item 2) and support at the rear of the Controller is recommended as shown in Figure 7. The panel cut out information is defined in Figure 8.
- Fix the Controller in place using the four screws removed previously (Figure 7, item 1).

Figure 7 - Rack mounting of a TIC

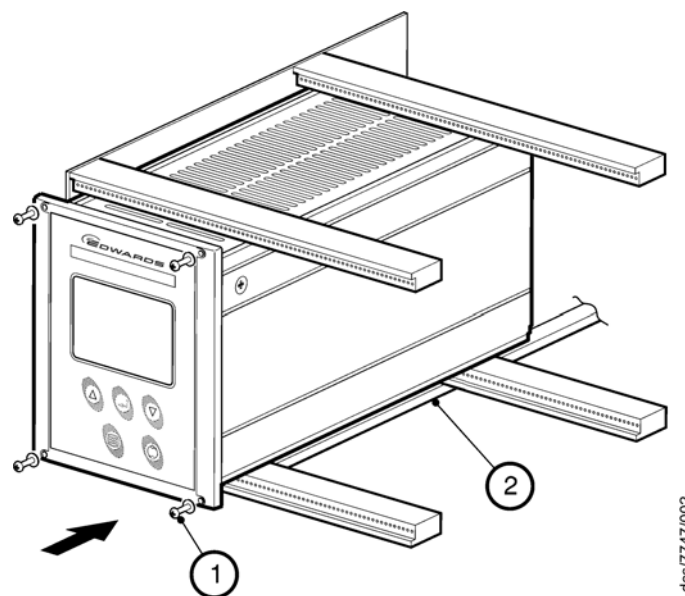

1. Fixing screw and washer
2. 19" rack guide rails

Figure 8 - Panel cut out drawing

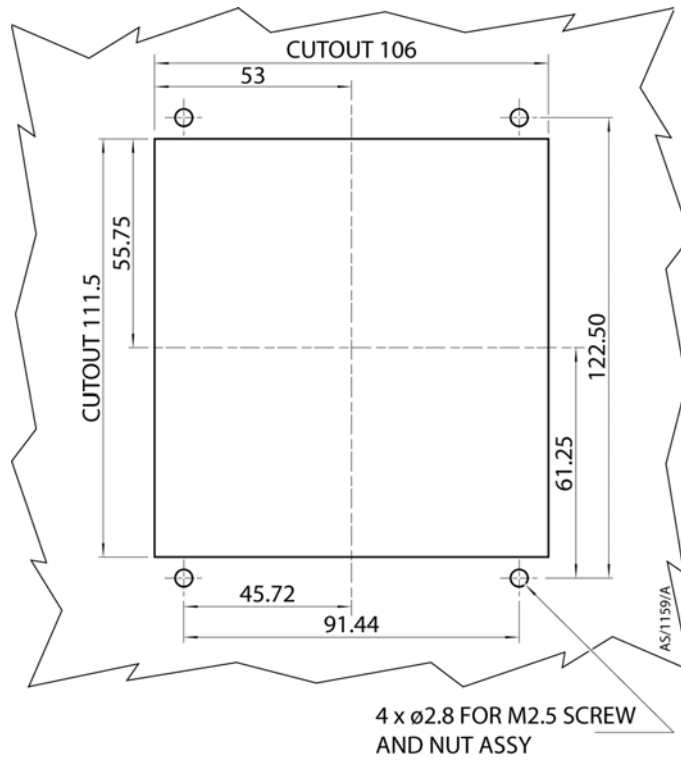

### 3.3 Controller electrical connections

*Note:* IGC Controllers are supported by both TIC 6-Gauge Controllers using gauge channels 4-6. Capacitance Manometers are only supported by TIC 6-Gauge Controller D39702000 using gauge channels 4-6.

Figure 9 - Rear panel connections

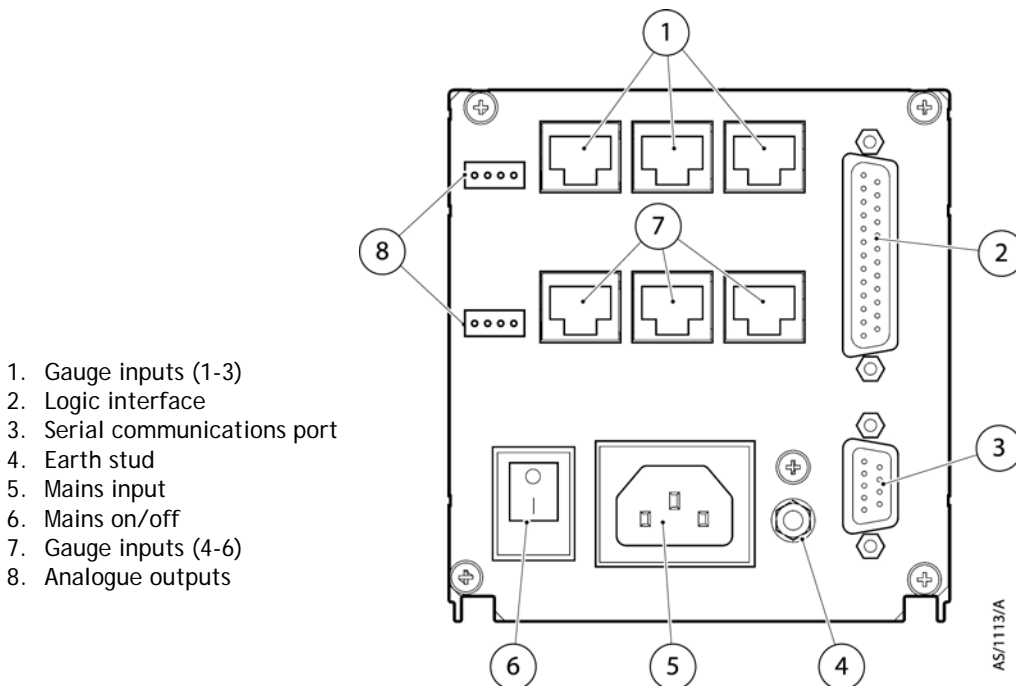

### 3.3.1 Connecting the electrical supply



#### WARNING

High voltages exist in the Controller when it is operating. Ensure that the Controller is earthed and observe all appropriate safety precautions for the safe installation and handling of electrical equipment. If you do not, there will be a danger of injury or death to people by electric shock.

Ensure that the electrical supply switch is set to 'off' and then connect the Controller to the electrical supply with an appropriate supply cable.

### 3.3.2 Additional earth bonding

The electrical supply cable normally provides protective earthing for electrical safety. If this is not the case, or if additional earth bonding is required, then the earth stud on the rear of the Controller (Figure 9, item 4) should be connected to your vacuum system earth. Connect a suitably earthed cable between the two nuts fitted to the earth stud on the rear of the TIC.

*Note:* Do not remove the bottom nut from the earth stud.

*Note:* If using the Controller in an area of high electrical noise, use of the earth stud will increase Controller immunity.

### 3.3.3 Connecting an active gauge

*Note:* IGC Controllers are supported by both TIC 6-Gauge Controllers using gauge connectors 4-6. Capacitance Manometers are only supported by TIC 6-Gauge Controller D39702000 using gauge connectors 4-6.

Up to six compatible active gauges can be fitted to the gauge connectors on the rear panel. Connect the gauges using Edwards active gauge cables to each of the six gauge sockets on the rear of the TIC.

#### CAUTION

Total user output should be limited to 38 W. This is the sum of the total gauge power and the power drawn from the logic interface connector.

Additionally for Capacitance Manometer compatible models power should be limited to 15 W. Use the following tables to calculate the power consumption.

Table 7 - Capacitance Manometer gauges

Model	Power
600, 622	1 W
655	7.5 W
658	15 W
659	Not supported

Table 8 - Other gauges

Model	Power
AIGX (normal operation)	8 W
AIGX (degas)	15 W
All other gauges	2 W

Table 9 - Logic connector Edwards accessories

Model	Power
3 Output Relay Box (D397-00-804)	0.75 W
6 Output Relay Box (D397-01-804)	1.5 W
Profibus Modules (D397-50-000)	5 W

**CAUTION**

If quoted rating is exceeded equipment specifications are not valid.

**CAUTION**

To connect a Capacitance Manometer gauge to a TIC a special cable is required (which includes an identification resistor). These are Edwards part numbers D40003030 for Model 622 and D40003050 for all other models. If the cable is not used the gauge will be damaged.

**CAUTION**

To ensure Capacitance Manometer gauge protection a minimum time of 1 second is required between disconnecting an alternative gauge type from that port and connecting the Capacitance Manometer.

### 3.3.4 Connecting the logic interface

#### 3.3.4.1 Introduction

*Note:* In most applications it will be preferable not to earth the logic interface power supply common to prevent earth loops inadvertently occurring.

**CAUTION**

Do not connect voltages greater than 24 V to the logic interface.

The logic interface provides a number of signals that can be used for monitoring the status of your vacuum system, and for controlling certain aspects of its operation. These signals can be broadly divided into two groups, control inputs and status outputs.

#### 3.3.4.2 Using control inputs

Control inputs provide a means of controlling the operation of the TIC and the associated vacuum system from external sources.

Gauge 1, 2, 3 Enable (Pins 9, 20, 21): The gauge enable inputs can be used to control the operation of the gauges. If gauge enable is open, the associated gauge cannot be turned on, and will turn off if it is operating. To enable the gauges, connect the required gauge enable line to 0 V.

*Note:* Only gauges that can be turned on and off will respond to this input. Refer to the gauge manual for further details.

SYSI: The System interlock input can be used to interlock the TIC to a system fail or control signal. When 'SYSI' is open, all gauges will turn off. The TIC will also trip into the fail condition. To clear the system interlock and allow the gauges to start, connect 'SYSI' to 0 V.

*Note:* Only gauges that can be turned on and off will respond to this input. Refer to the gauge manual for further details.



### WARNING

'SYSI' is not fail safe and should not be relied upon for safety critical applications.

#### 3.3.4.3 Using status outputs

Status outputs provide a means for external systems to react based upon the current state of the TIC.

**Relay setpoints:** The setpoint outputs can be used to interface to external logic or can be used to drive relays. Each output can be configured in software to activate at a certain pressure. Refer to [Section 4.11](#) for how to configure these outputs. Each relay can be manually controlled. Refer to [Section 4.5](#).

Two types of relay box are available as options from Edwards with either 3 or 6 relay outputs.

The relay box has built in relays that can switch external loads and provides a connector to interface to an external system. Refer to the relay box instructions for further information on using the setpoint outputs.

To drive a relay without a relay box, connect the coil of a suitable 24 V d.c. relay between 'Setpoint Output' (negative) and 'Power Supply Positive' (positive).

**Alarm:** Alarm can be used to interface to external logic or can be used to drive a relay. This output is normally active and will become inactive in the event of an alarm condition.

To drive a relay, connect the coil of a suitable 24 V d.c. relay between 'Alarm Output' (negative) and 'Power Supply Positive' (positive).

#### 3.3.5 Connecting the serial interface

The TIC has two serial communications protocols built in, RS232 and RS485. RS232 is the simpler interface and can be used to allow a host PC to control the TIC. RS485 allows a host PC to control a small network of TICs.

##### 3.3.5.1 Connecting RS232

The TIC is fitted with a 9-way 'D' type socket on the rear panel, refer to [Figure 9](#), item 3. The interface uses two lines for data transfers and an additional line as a signal common. Hardware handshaking is not implemented.

If connecting to an IBM compatible PC fitted with a 9-way 'D' type socket then a 'straight through' male-female 9-way extension cable can be used to connect the TIC to the computer as shown in [Figure 10](#). Connection to an IBM PC fitted with a 25-way serial connector should be made as shown in [Figure 11](#).

Use shielded cable for the interface to reduce interference problems and limit the length of the RS232 link to less than 10 metres. For longer links, either install line drivers or use RS485.

Figure 10 - IBM PC RS232 interface - 9-way

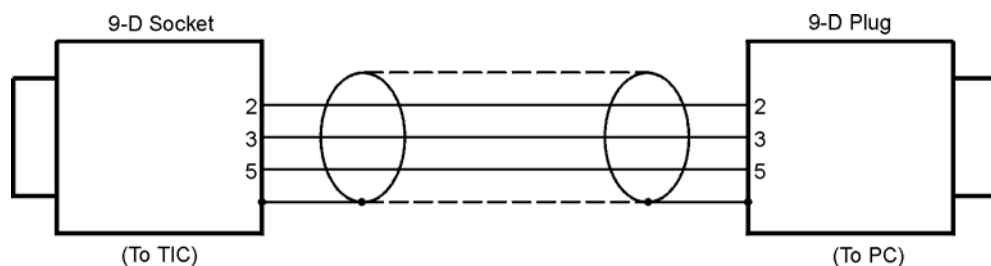

dcsl/0121/001

Figure 11 - IBM PC RS232 interface - 25-way

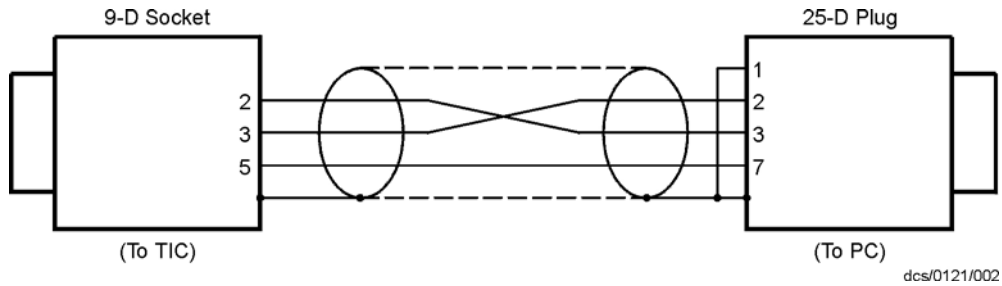

### 3.3.5.2 Connecting RS485

RS485 provides the TIC with the capability to be networked with other TICs and a host PC as shown in Figure 12.

#### CAUTION

All of the ground connections are tied together. If differences exist in the local ground voltage, damage could occur. If the TICs being networked are liable to experience different ground potentials, a suitable RS485 isolator should be connected between them.

Use shielded cable for the interface to reduce interference problems and limit the length of the RS485 link to less than 1000 metres.

Long links may require the addition of 120 Ω terminating resistors at each end of the link to improve communications reliability.

Figure 12 - RS485 TIC network

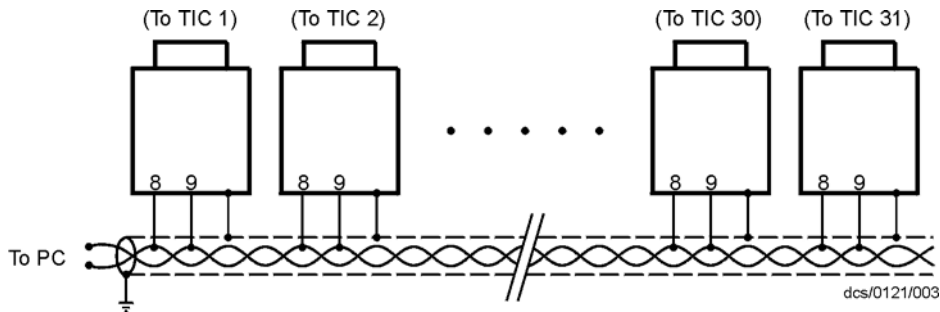

## 4 Operation

### 4.1 Front panel description

Figure 13 - Front panel display

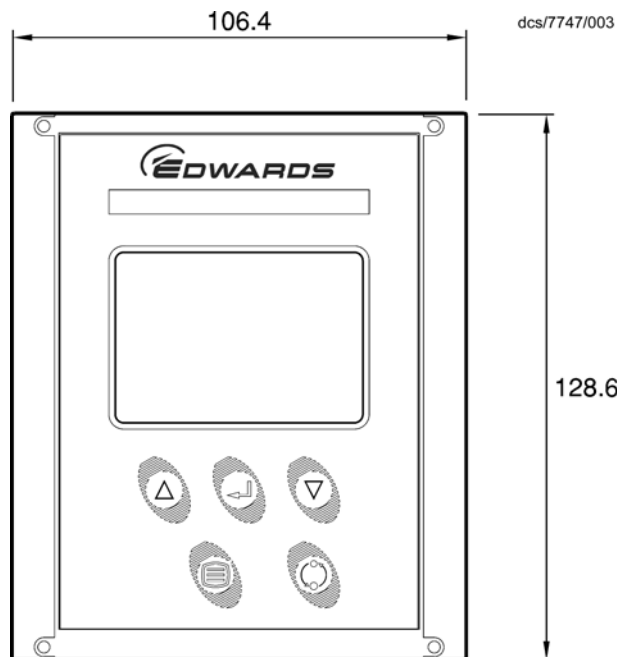

Table 10 - Front panel symbols and their functions

Symbol	Name	Function
	UP	Move up through a menu. Cycle selected numerical values up. Cycle a selected list item upwards.
	DOWN	Move down through a menu. Cycle selected numerical values down. Cycle a selected list item downwards.
	SELECT	Enter the highlighted sub-menu. Edit the highlighted list or numerical item. Move to the next digit of a numerical value. Jump to the setup screen for the highlighted gauge.
	MENU	Switch between the default view screen and the main menu. Exit the current sub-menu or setup screen. Abort edit of a selected list item. Move to the previous digit of a numerical value.
	CYCLE	Turn a highlighted gauge on or off.

## 4.2 Menu structure

Figure 14 and 15 show the view screen shortcuts and menu structure for the TIC. They also give an indication as to what buttons will take you where within the menu layout.

Figure 14 - View screen shortcuts

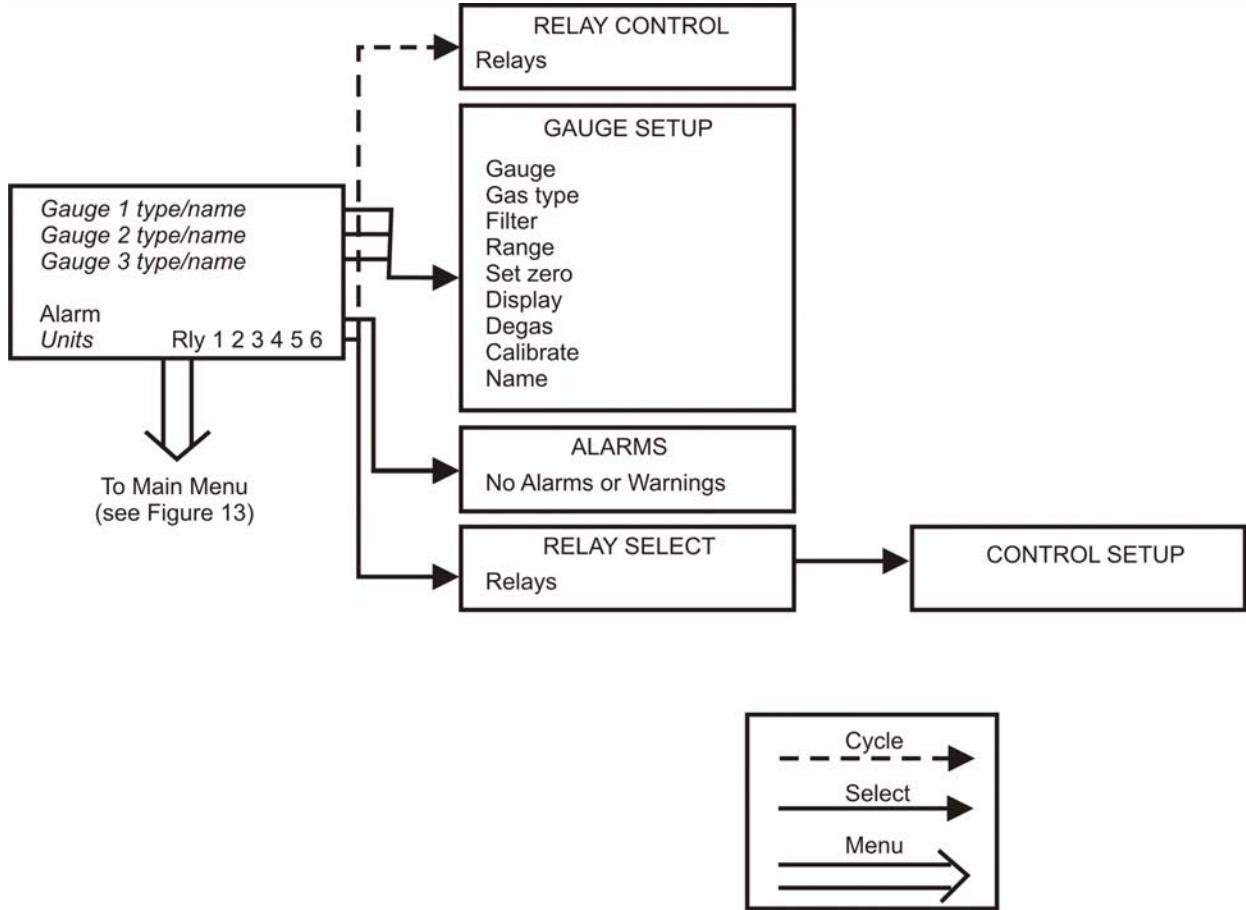
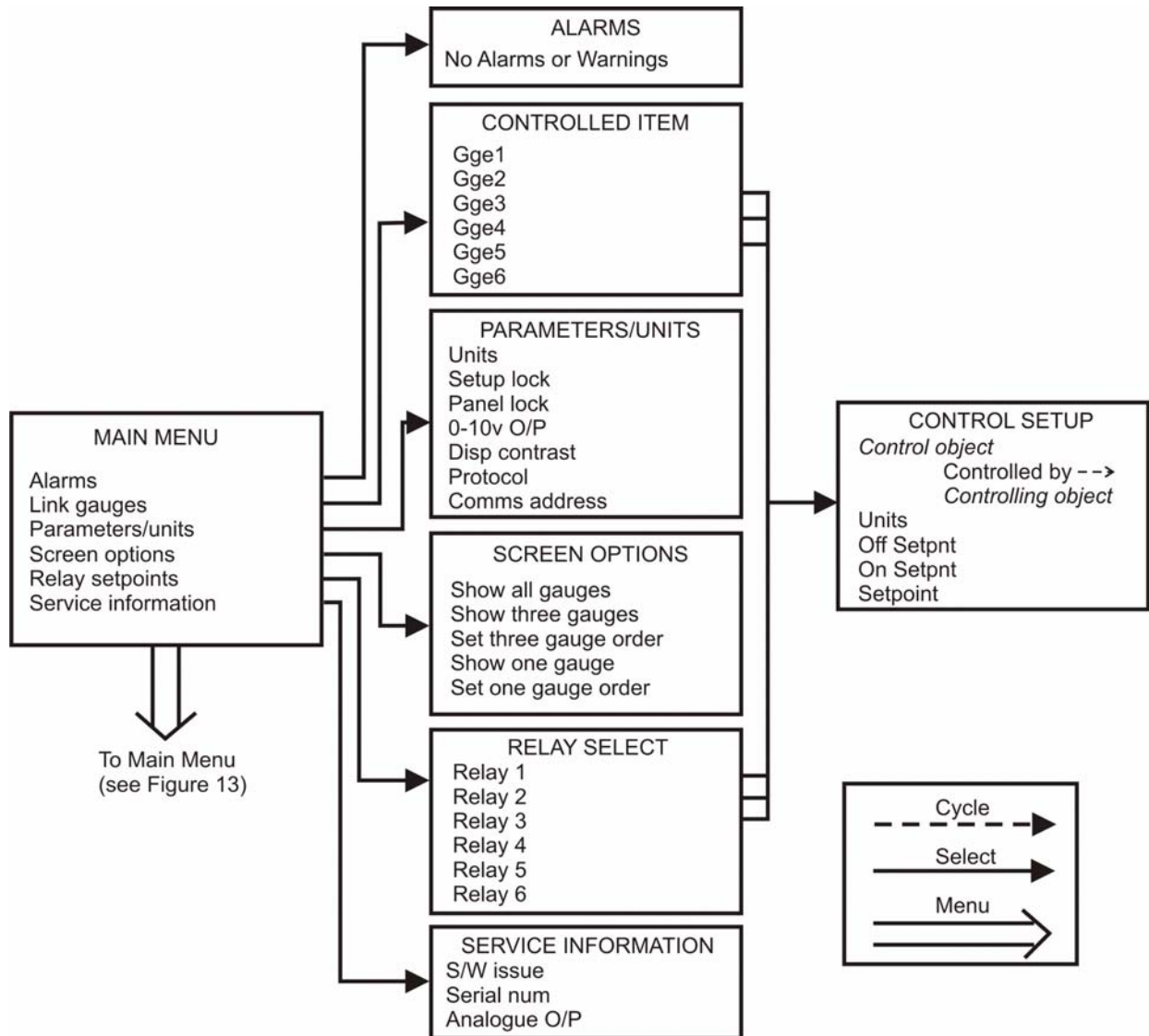



Figure 15 - Menu structure



### 4.3 Navigating the menu

This section summarises the display navigation method for the TIC. There are 4 buttons for menu navigation and configuration tasks. A fifth button is used for switching gauges ON and OFF. In most configuration tasks there are no more than three menu levels.

Refer to [Table 10](#) for a description of the functions that the buttons on the front panel perform.

## 4.4 The view screen

The view screen can be set to various view options; refer to [Section 4.13](#) for the various view screen options which can be set. The following, describes the view screen that shows three gauges. (Refer to [Figure 16](#)).

The status of the setpoint relays is shown at the bottom line of the view screen. Relays that are on are shown in reverse video.

Active gauges are fitted with a resistor that is unique to the type of gauge. When a new gauge is connected, TIC automatically identifies the gauge and indicates that a new gauge has been detected as shown in [Figure 16](#).

Figure 16 - New gauge connected



In this example new gauges have been plugged into channels 1 and 2. Scroll up/down ( $\Delta$  /  $\nabla$ ) to the selected gauge channel and press the 'Select' ( $\leftarrow$ ) button. The display will identify the gauge type and display either an output or message. Gauges, which measure up to atmospheric pressure (high pressure gauges), will automatically display an output.

## 4.5 Turning gauges and relays ON/OFF

Pressing the 'Cycle' ( $\odot$ ) button with view screen items selected will turn the items 'on/off'.

Low pressure gauges (AIGX and AIM) default to 'OFF', as they should not be operated at pressures greater than their upper range limit. Low pressure gauges may be switched on manually, by scrolling to the display line and pressing the 'Cycle' ( $\odot$ ) button, or they may be linked to and protected by a suitable high pressure gauge (refer to [Section 4.11](#)).



If the selected item is the relay status line, a list of the relays will appear. Scroll to the required relay, use the 'cycle' ( $\odot$ ) button to switch the item. When the relay is activated the display section on the view screen will change to reverse video.

**Note:** *Low pressure gauges must be 'enabled' by the Logic Interface before TIC can turn them ON and OFF. This is done either by fitting a link across the appropriate pins on the mating connector, or using an external switch.*

*The logic interface plug supplied with the TIC has links for this purpose.*

*If System Interlock (SYSI) is active, pressing the 'Cycle' ( $\odot$ ) button will not switch on low pressure gauges. Conversely, if SYSI is opened during the vacuum cycle, all connected controllable components will be switched OFF.*



## 4.6 Changing list items



To change a list item, scroll to the required line and press the 'Select' () button. The list can then be scrolled using the up and down arrows (/).

Pressing the 'Select' () button will accept the adjustment and return the highlight to the row item, allowing another item to be selected for adjustment.

Pressing the 'Menu' () button will cancel the adjustment and return the highlight to the row item, allowing another item to be selected for adjustment.

## 4.7 Changing numerical values

To change a numerical item, scroll to the required line and press the 'Select' () button. The first number will then be highlighted and can be changed using the up and down arrows (/).

The 'Select' () button will move the highlight to the next digit with each successive press, allowing the complete number to be entered. Pressing the 'Select' () button with the last digit selected will accept the adjustment and return the highlight to the row item, allowing another item to be selected for adjustment.







At any time, mistakes can be corrected by pressing the 'Menu' () button. This will move the highlight to the previous digit with each successive button press, allowing corrections to be made. Pressing the 'Menu' () button with the first digit selected will cancel the adjustment and return the highlight to the row item, allowing another item to be selected for adjustment.

Figure 17 - Changing numerical values

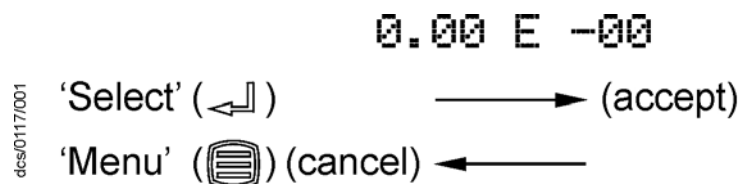

### 4.7.1 Entering negative components e.g. 5.00E-03



To enter a negative exponent you must first enter the number, then change the sign of exponent. For example, to enter 5.00E-03:

First enter the number using the (/) and () buttons as above

5.00E + 03

Then use the 'menu' () button to move to the + character



5.00E + 03

Use the (/) buttons to change the character to -

5.00E - 03

Finally, press the 'select' () button three times to complete the entry

5.00E - 03

The entry is now complete; use the (/) button to move to the next list item, or the 'menu' () button to return to other menus.

## 4.8 Gauge setup

### CAUTION

All setups in the TIC are held in non-volatile memory. Non-volatile memory has a limit on the number of times its content can be changed. Current minimum lifetime is 100,000 changes on a particular section, this equates to in excess of 1 change per hour every hour for 10 years. If you exceed this number of changes random data may be stored leading to unexpected system behaviour.

When a new gauge has been identified, scrolling to the selected gauge and pressing the 'Select' ( ) button accesses the 'Gauge Setup' screen. (Refer to Table 11).

Table 11 - Default setup options (all gauges)

Menu option	Description
Gauge	Indicates type of gauge connected.
Gas type	Allows the user to select the gas type. Choice of: N <sub>2</sub> , He, Ar, CO <sub>2</sub> , Ne, Kr or Volts.  <i>Note: For gas dependent gauges, it is important that the correct gas is selected to ensure correct pressure indication.</i>
Filter	Allows the user to select filter status. Filter 'OFF' gives pressure output as reported by the gauge (update rate 3 per second approx). Filter '1 sec' applies a one second moving average to the readings, reducing the effects of noise on reading stability.
Name	Allows the user to name gauges. 4 characters can be set appropriate to the system, A-Z, 0-9, _ (space).  <i>Note: If the gauge name is set the name will appear if the gauge is disconnected. To reset to the gauge type ensure 4 spaces appear in the gauge name setup.</i>

### 4.8.1 Default setup options (all gauges)

All gauges have the following default items on their respective setup screens. (The example below shows the APMG as the connected gauge).

Figure 18 - Gauge setup screen

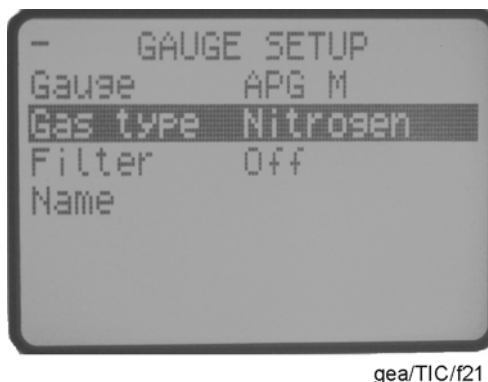

*Note: Active Strain Gauges (ASG) are gas independent. Selection of any gas type will give the same pressure output.*

### 4.8.2 Gauge status messages

Standard status messages are shown in Table 12.

Table 12 - Gauge status messages

Diagnostic messages	Description
Not Connected	Indicates that no gauge has been connected to TIC, or if a cable has been connected, the gauge may not be connected to the other end.
Disconnected	The gauge connection has been removed intentionally or accidentally.
New ID	Indicates that a new gauge has been connected to TIC. The gauge is recognised by TIC, but must be acknowledged by the user before TIC will allow the gauge to operate on the system.
Uknw	Indicates that the connected gauge is not recognised by TIC. In this case, TIC will continue to display the gauge as Uknw and will give an output in volts only.

### 4.8.3 Active Pirani Gauge (APG)

**Note:** For a detailed specification and instructions regarding the use of the APG and APGX gauges refer to the appropriate Instruction Manual (D021-71-885, D023-71-880 and D023-91-880).

The Active Pirani Gauge (APG) is a gas dependent high-pressure thermal conductivity gauge. The measuring range of the APG-M and the corrosion resistant APG-MP is 100 mbar to  $10^{-3}$  mbar ( $75$  to  $7.5 \times 10^{-4}$  Torr); the range of the APG-L is 10 mbar to  $10^{-4}$  mbar ( $7.5$  to  $7.5 \times 10^{-5}$  Torr). All of the gauges will indicate pressure up to 1000 mbar (750 Torr) at reduced accuracy.

**Note:** At pressures above 600 mbar, sensitivity is reduced and TIC displays atmospheric pressure.

**Note:** Before the APG is used and periodically thereafter, atmosphere and vacuum calibration should be carried out in accordance with the directions shown in the Instruction Manual (D021-71-885, D023-71-880 and D023-91-880).

The APG is set up as per the default gauge setup instructions shown in Section 4.8.1 above.

There are no additional setup options for APG. (Refer to Default setup options (all gauges) Section 4.8.1.

There are no error/diagnostic messages specific to APG. (Refer to Table 13).

Table 13 - Error/diagnostic monitoring APG

Diagnostic messages	Description
Over Range	(Gauge output >11.000 V) Indicates that either the measured gas pressure is outside the range of the gauge, or that there is a fault with the gauge. Clear the error message, reduce the process pressure to within the range of the gauge, 'Scroll' to the gauge display line and press 'Cycle'. If the gauge fails to give a pressure readout it should be replaced. This is most likely to occur with gases of low molecular weight such as Helium.
Under Range	(Gauge output <1.800 V) Indicates that there is either a calibration error, or the gauge is faulty. Calibrate the gauge as described in the instruction manual. If the fault persists, replace the gauge.

### 4.8.4 Active Linear Pirani Gauge (APGX)

The Active Linear Pirani Gauge (APGX) is a gas dependent high-pressure thermal conductivity gauge. The measuring range of the APGX-M and the corrosion resistant APGX-MP is 100 mbar to  $10^{-3}$  mbar ( $75$  to  $7.5 \times 10^{-4}$  Torr); the range of the APGX-L is 10 mbar to  $10^{-4}$  mbar ( $7.5$  to  $7.5 \times 10^{-5}$  Torr). All of the gauges will indicate pressure up to 1000 mbar (750 Torr) at reduced accuracy.

The Linear Convection Gauges (APGX-H) are gas dependent, high pressure thermal conductivity and convection gauges. The measuring range of the APGX-H is 1333 to  $3 \times 10^{-4}$  mbar ( $1000$  to  $2.3 \times 10^{-4}$  Torr). At pressures above 10 mbar, pressure measurement is by convection, which provides consistent sensitivity and accuracy to the top of the measuring range.

APGX(s) are permanently enabled and hence give an output as soon as they are recognised.

The APGX is set up as per the default gauge setup instructions shown in Section 4.8.1. (Refer to Figure 19).

APGX has menu options in addition to those shown. Refer to Default setup options (all gauges) Section 4.8.1. (Refer to Table 14).

Table 14 - Setup options APGX

Menu option	Description
Calibrate	Allows the user to adjust the APGX at atmosphere and vacuum. Connect the APGX to TIC and allow it to operate at atmospheric pressure for at least 10 minutes. 'Scroll' to 'Calibrate' and press 'Select'. 'Command Sent' appears for 1 s to confirm instruction has been carried out. Reduce the system pressure to $1 \times 10^{-4}$ mbar ( $7.5 \times 10^{-5}$ Torr) or below for the APGX-M or APGX-MP, or $1 \times 10^{-5}$ mbar ( $7.5 \times 10^{-6}$ Torr) or below for the APGX-L and APGX-H. Press 'Select'. 'Command Sent' appears after 1 second to confirm instruction has been carried out. Press 'menu' (☰) button to return to the display screen.

Figure 19 - Gauge setup screen APGX-M



gea/TIC/f22

APGX has an in-built error monitoring capability. (Refer to Table 15).

**Table 15 - Error/diagnostic monitoring APGX**

Diagnostic messages	Description
Over Range	(Gauge output = 9.750 V) Indicates that there is a fault with the gauge and it should be replaced.
Under Range	(Gauge output <0.300 V) Indicates that there is a fault with the gauge and it should be replaced.
Filament Fail	(Gauge output = 9.500 V) Indicates that the gauge filament is broken. The gauge should be replaced.
Cal Error	(Gauge output = 9.600 V) Indicates that the gauge has gone out of calibration. This could be because of the wrong gas type being selected, pressing the atmosphere and vacuum adjustment button in mid-range or contamination of the gauge. The gauge should be re-adjusted as described in Table 14. If the fault persists the gauge should be replaced.
No Tube	(Gauge output = 9.700 V) Indicates that the replaceable gauge tube is missing or incorrectly fitted. Check the tube and ensure that the two fixing screws are properly secured.  <i>Note: APGX-H only.</i>

*Note: There is a +/- 50 mV tolerance on the gauge outputs shown in Table 15.*

#### 4.8.5 Active Thermocouple Gauge (ATC-E) control

*Note: For a detailed specification and instructions regarding the use of the ATC-E, refer to the Instruction Manual (D351-08-880).*

Active Thermocouple Gauges are low cost, gas dependent, high pressure, thermal conductivity gauges. The ATC-E electronics module is compatible with two types of thermocouple gauge tube to give a wide measuring range. (Refer to Table 16).

**Table 16 - ATC-D and ATC-M gauge tubes**

Tube name	Tube part number	Pressure measuring range
ATC-D	D355-12-000	65 to $6.5 \times 10^{-2}$ mbar (50 to $5 \times 10^{-2}$ Torr)
ATC-M	D355-13-000	1.3 to $1.3 \times 10^{-3}$ mbar (1 to $1 \times 10^{-3}$ Torr)

Before connecting to TIC, the ATC-E must be configured for the type of gauge tube (ATC-D or ATC-M) to be used. This is done by selecting the body colour of the tube with the two-position switch.

*Note: For a valid pressure readout, the switch must be correctly set on the ATC-E.*

*Note: At pressures above 600 mbar, ATC-D sensitivity is reduced and TIC displays atmospheric pressure. The ATC-M does not display pressures above 4.2 mbar.*

There are no additional setup options for ATC-E. (Refer to Default setup options (all gauges) Section 4.8.1.

Please refer to Table 17 for the error and diagnostic information for the ATC-E gauge.

Table 17 - Error/diagnostic monitoring ATC-E

Diagnostic messages	Description
Over Range	(Gauge output >11.000 V) Indicates that either the measured gas pressure is outside the range of the gauge, or that there is a fault with the gauge. Clear the error message, reduce the process pressure to within the range of the gauge, scroll to the gauge display line and press 'Cycle'. If the gauge fails to give a pressure readout it should be replaced. This is most likely to occur with gases of low molecular weight such as Helium.
Under Range	(Gauge output <1.500 V) Indicates that the gauge is faulty and should be replaced.

#### 4.8.6 Active Strain Gauge (ASG) control

**Note:** For a detailed specification and instructions regarding the use of the ASG, refer to the Instruction Manual (D357-25-880).

Active Strain Gauges are gas independent diaphragm gauges. There are two gauges with full scales of 2000 and 1000 mbar (1500 and 750 Torr) respectively. Both gauges measure pressures down to 1 mbar ( $7.5 \times 10^{-1}$  Torr), have a linear pressure characteristic and output voltage directly proportional to the pressure. The output is 0 to 10 V d.c. over the measuring range of the gauge.

ASG has menu options in addition to those shown. (Refer to Default setup options (all gauges) Section 4.8.1. (Refer to Table 18 and Figure 20).

Table 18 - Setup options ASG

Menu option	Description
Range	Indicates full scale of available gauge options. Choice of: 1000 or 2000
Set zero	Allows the user to zero the gauge. Reduce the system pressure to $2 \times 10^{-2}$ mbar ( $1.5 \times 10^{-2}$ Torr) or below for the 2000 mbar (1500 Torr) ASG or $1 \times 10^{-2}$ mbar ( $7.5 \times 10^{-3}$ Torr) or below for the 1000 mbar (750 Torr) ASG. 'Scroll' to 'Set zero' and press 'Select'. 'Command Sent' appears for 1 s to confirm instruction has been carried out.
Display	Indicates pressure display options. Choice of: Float (mantissa and exponent). Fixed (number to 1 decimal place).

Figure 20 - Gauge setup screen ASG



gea/TIC/f23

Please refer to Table 19 for the error and diagnostic information for the ASG.



**Table 19 - Error diagnostic monitoring ASG**

Diagnostic message	Description
Over Range	(Gauge output >11.000 V) Indicates that either the measured gas pressure is outside the range of the gauge, or that there is a fault with the gauge. Clear the error message, reduce the process pressure to within the range of the gauge, scroll to the gauge display line and press 'Cycle'. If the gauge fails to give a pressure readout it should be replaced.
ASG Cant Zero	Indicates that the gauge output is outside the range -100 mV to +100 mV. The most likely cause of this error is either attempting to zero the gauge at too high a pressure or a gauge fault. Attempt to zero the gauge again and if the fault persists, the gauge should be replaced.

#### 4.8.7 Active Inverted Magnetron (AIM) Gauge control

**Note:** This section covers both standard (AIM-S) and linear (AIM-X) output gauges including low magnetic field (-SL or -XL) and bakeable (type DN40CF) versions.

**Note:** For a detailed specification and instructions regarding the use of the AIM-S and AIM-X gauges, refer to the appropriate Instruction Manual (D146-41-885 & D146-61-880).

Active Inverted Magnetron (AIM) gauges are gas dependent, cold cathode, ionisation gauges, which measure pressures in the range  $1 \times 10^{-2}$  to  $1 \times 10^{-9}$  mbar ( $7.5 \times 10^{-3}$  to  $7.5 \times 10^{-10}$  Torr). There are a number of variants, offering standard (AIM-S) and linear (AIM-X) outputs, low external magnetic field (AIM-SL and AIM-XL) variants for use on sensitive scientific instruments and special bakeable tubes for use in UHV applications.

There are no additional setup options for AIM. (Refer to Default setup options (all gauges) [Section 4.8.1](#).)

Please refer to [Table 20](#) for the error and diagnostic information for the AIM gauge.

**Table 20 - Error/diagnostic monitoring AIM**

Diagnostic messages	Description
Over Range	(Gauge output >11.000 V) Indicates that the measured gas pressure is outside the range of the gauge or the wrong gas type has been selected. Check the gas selected is correct, switch off the gauge, clear the error, reduce the process pressure to within the range of the gauge and press 'Cycle'. If the error persists, there is a fault with the gauge and the electronics module should be replaced.
Under Range	(Gauge output <0.025 V) Indicates that there is a fault with the gauge or cable. Replace the cable and if the fault persists, the electronics module should be replaced.
Striking	Indicates that the gauge is attempting to strike. TIC will continue in this mode for up to 15 minutes.
Not Struck	Indicates that the gauge failed to strike within 15 minutes. This is most likely to be because of the gauge tube becoming contaminated. The gauge tube should be inspected for signs of contamination or debris. If the anode and cathode are not bright, the gauge should be cleaned or the electrodes replaced (D145-45-802 or D146-61-802) as described in the AIM instruction manual.

### 4.8.8 Active Ion Gauge (AIGX-S) control

*Note:* TIC does not support the AIGX-D variant of the AIGX range.

*Note:* For a detailed specification and instructions regarding the use of the AIGX, refer to the Instruction Manual (D048-50-880).

The Active Ion Gauge (AIGX-S) is a fully integrated active instrument, with a measuring range of  $6.6 \times 10^{-2}$  to  $6.6 \times 10^{-10}$  mbar ( $5 \times 10^{-2}$  to  $5 \times 10^{-10}$  Torr). The gauge has a 1 volt/decade linear output in the range 0 to 10 V d.c. The AIGX-S is supplied with two filaments, which may be manually selected at the gauge head. For maximum filament life, the gauge includes automatic emission current switching and high-pressure shutdown. The only user selectable features are a setpoint and degas facility.

The gauge also includes a comprehensive range of diagnostic outputs, which are displayed on TIC.

AIGX has menu options in addition to those shown. (Refer to Default setup options (all gauges) Section 4.8.1. (Refer to Table 21 and Figure 21).

Table 21 - Setup options AIGX

Menu option	Description
Degas	<p>Allows the user to degas the gauge. 'Scroll' to 'Degas' and press 'Select'. 'Command Sent' appears for 1 s to confirm degas sequence initiated.</p> <p><i>Note:</i> Whilst the gauge is degassing, the pressure output may read slightly higher than normal.</p> <p>The maximum duration of the degas cycle is 3 minutes, during which the pressure shown on the 'View' screen will be suffixed with a 'DG' e.g. 1.67<sub>DG</sub> - 09. At the end of the cycle, the gauge will automatically return to its normal operating mode.</p> <p>If the pressure rises above <math>1.3 \times 10^{-4}</math> mbar (<math>1 \times 10^{-4}</math> Torr) during the cycle, degas will automatically stop until the pressure falls below <math>4 \times 10^{-5}</math> mbar (<math>3 \times 10^{-5}</math> Torr), at which point degas resumes for the remainder of the cycle.</p> <p><i>Note:</i> There is no facility enabling degas to be manually switched off mid-cycle.</p>

Figure 21 - Gauge setup screen AIGX

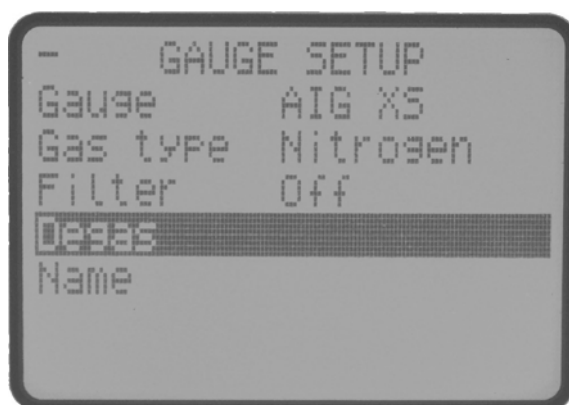

gea/TIC/f24

AIGX has an in-built error monitoring capability. (Refer to Table 22).

Table 22 - Error/diagnostic monitoring AIGX

Diagnostic messages	Description
Over Range	(Gauge output >9.800 V) Indicates that there is a fault with the gauge and the electronics module should be replaced.
Over Pressure	(Gauge output = 9.700 V) Indicates that the gauge has automatically shut down, because of pressure rising above $6.6 \times 10^{-2}$ mbar ( $5 \times 10^{-2}$ Torr). Reduce pressure and re-enable the gauge.
Emission Error	(Gauge output = 9.500 V) Indicates that either the filament is broken (switch over) or gauge was enabled at too high a pressure - reduce and re-enable. Electrical supply is out of spec - check the cables (length and cross section).
Under Range	(Gauge output <0.025 V) Indicates that either the gauge internal fuse has blown or there is a fault with the gauge. The fuse should be replaced as described in the AIGX instruction manual and if the fault persists, the electronics module should be replaced.
Initialising	Indicates that the gauge is establishing an emission current. This usually takes about 5 seconds.

#### 4.8.9 Wide Range Gauge (WRG)

**Note:** For a detailed specification and instructions regarding the use of the WRG, refer to the Instruction Manual (D147-01-885).

The WRG is a combined Pirani and inverted magnetron gauge in a single compact unit. The WRG measures pressure from atmosphere down to  $1 \times 10^{-9}$  mbar ( $7.5 \times 10^{-10}$  Torr). The WRG is gas dependent and has a log/linear output in the range 2-10 V d.c. The Pirani part of the gauge measures from atmosphere to  $1 \times 10^{-3}$  mbar ( $7.5 \times 10^{-3}$  Torr) while the inverted magnetron measures from  $1 \times 10^{-2}$  down to  $1 \times 10^{-9}$  mbar ( $7.5 \times 10^{-3}$  to  $7.5 \times 10^{-10}$  Torr). Output from both sensors is used to determine pressure between  $1 \times 10^{-2}$  and  $1 \times 10^{-3}$  mbar ( $7.5 \times 10^{-3}$  and  $7.5 \times 10^{-4}$  Torr).

WRG has menu options in addition to those shown. (Refer to Default setup options (all gauges) Section 4.8.1. (Refer to Table 23 and Figure 22).

Table 23 - Setup options WRG

Menu option	Description
Calibrate	Allows the user to perform the atmosphere and vacuum adjustment on the WRG.  Connect the WRG to TIC and allow it to operate at atmospheric pressure for at least 10 minutes.  'Scroll' to 'Calibrate' and press 'Select'.  'Command Sent' appears for 1 s to confirm instruction has been carried out.  The WRG will automatically perform a Pirani sensor vacuum setting every time it is pumped down below $1 \times 10^{-4}$ mbar ( $7.5 \times 10^{-5}$ Torr).

Figure 22 - Gauge setup screen WRG

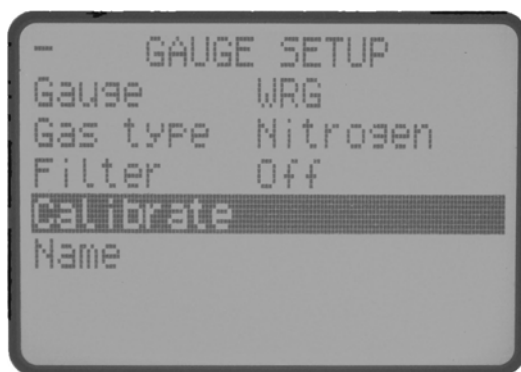

gea/TIC/f25

**Note:** If the Pirani sensor is replaced (see WRG instruction manual D147-01-885) it may initially fail to indicate pressures less than  $1 \times 10^{-3}$  mbar ( $7.5 \times 10^{-4}$  Torr). In this case a manual vacuum calibration is required. Pump down to  $1 \times 10^{-5}$  mbar ( $7.5 \times 10^{-6}$  Torr) or below before performing the CAL operation as described in the instruction manual.

WRG has an in-built error monitoring capability. (Refer to Table 24).

Table 24 - Error/diagnostic monitoring WRG

Diagnostic messages	Description
Over Range	(Gauge output >10.600 V) Indicates that there is a fault with the gauge and it should be replaced.
Not Struck	(Gauge output = 1.300 V) Indicates that the magnetron part of the gauge has not struck. The gauge tube should be inspected for signs of contamination or debris. If the anode and cathode are not bright, the gauge should be cleaned as described in the WRG instruction manual.
Striker Fail	(Gauge output = 1.200 V) Indicates that the striker filament has broken. The electrode assembly (D147-01-802) should be replaced as described in the WRG instruction manual.
Mag Fail	(Gauge output = 1.100 V) Indicates that the magnetron part of the WRG has shorted out. This could be because of contamination or a foreign body. The WRG should be cleaned as described in the instruction manual. If this fails to rectify the fault, the WRG should be serviced and the electrode assembly (D147-01-802) replaced as described in the instruction manual.
Filament Fail	(Gauge output = 1.000 V) Indicates that the Pirani element of the gauge has failed. The most likely fault being a broken filament. The WRG should be serviced as described in the instruction manual.
Under Range	(Gauge output <0.950 V) Indicates that there is a fault with the gauge and the electronics module should be replaced.

#### 4.8.10 Ion Gauge Controller (IGC) - gauge type displayed as 'IONEB'

**Note:** For a detailed specification and instructions regarding the use of the IGC refer to the instruction manual (D048-40-880).

The Ion Gauge Controller is the only gauge compatible with a TIC where the gauge is not powered from the TIC. The Ion Gauge Controller requires a (90-264 Vac) mains supply and has a separate electrode head. The TIC is used for control and monitoring of the IGC.

The IGC and head is a gas dependent ionisation gauge system with a measuring range of around  $5 \times 10^{-3}$  to  $2 \times 10^{-11}$  mbar ( $3.75 \times 10^{-3}$  to  $1.5 \times 10^{-11}$  Torr).

IGC has menu options in addition to those shown at the beginning of Section 4.8.

Table 25 - Setup options IGC

Menu Option	Description												
Degas	<p>Allows the user to Degas the gauge head. After an Ion gauge has been at atmosphere for some time (for example during transit) or if the grid has become contaminated it will be necessary to Degas the head to bake-off the moisture and other contamination. 'Scroll' to 'Degas' and press 'Select'. 'Command Sent' appears for 1 second to confirm degas sequence demanded.</p> <p><b>Note:</b> If the IGC is off (no emission) the Degas demand will be ignored. Degas is stopped either by a manual command or by timer in IGC (20-30 mins). To stop Degas manually another Degas command should be sent.</p> <p>The IGC provides actual degas status feedback. There are three possible Degas states: off (normal), on and inhibited. The IGC will inhibit degas if the pressure is too high and Degas will resume once the pressure reduces. Degas status is displayed with gauge signal. If the gauge display is voltage the units will change from 'V' to either 'VDG' or 'VDI' for either Degas or Degas Inhibited. If the display is pressure the 'x10' part of the display will change to either DG or DI (for Degas or Degas Inhibited). With a head sensitivity of 10/mbar the pressure should be below <math>2 \times 10^{-5}</math> mbar to ensure degas will not be inhibited but it is recommended that Degas is not initiated with pressures above <math>1 \times 10^{-6}</math> mbar. During Degas pressure reading accuracy is reduced as the head sensitivity is changed by the heating process.</p>												
Filament	<p>Allows the user to select which of the two filaments '1' (default) or '2' are used. 'Scroll' to 'Filament' and press 'Select'. 'Scroll' to change option and press 'Select' for change to occur.</p> <p><b>Note:</b> You cannot change filament if the emission is on.</p>												
Head	<p>Allows the user to select which of the two controller heads (sockets) 'A' (default) or 'B' is used. 'Scroll' to 'Head' and press 'Select'. 'Scroll' to change option and press 'Select' for change to occur.</p> <p><b>Notes:</b> You cannot change head if the emission is on.</p>												
Emission	<p>Allows the user to select the emission current. Options are 'AUTO' (default); 100 <math>\mu</math>A, 1 mA or 10 mA. If 'AUTO' is selected the TIC will automatically set the emission current based on the gauge pressure. Changing emission current does not start emission. The accuracy of the gauge can be optimised by selecting the filament emission current most suited to the operating pressure range as shown in the following table:</p> <table border="1" style="margin-left: auto; margin-right: auto;"> <thead> <tr> <th>Ion gauge pressure</th> <th>Emission current</th> <th>Menu selection</th> </tr> </thead> <tbody> <tr> <td>&gt; 1E-4</td> <td>100 <math>\mu</math>A</td> <td>100 UA</td> </tr> <tr> <td>1E-8 to 1E-4</td> <td>1 mA</td> <td>1 MA</td> </tr> <tr> <td>&lt; 1E-8</td> <td>10 mA</td> <td>10 MA</td> </tr> </tbody> </table> <p>'Scroll' to 'Emission' and press 'Select'. 'Scroll' to change option and press 'Select' for change to occur.</p>	Ion gauge pressure	Emission current	Menu selection	> 1E-4	100 $\mu$ A	100 UA	1E-8 to 1E-4	1 mA	1 MA	< 1E-8	10 mA	10 MA
Ion gauge pressure	Emission current	Menu selection											
> 1E-4	100 $\mu$ A	100 UA											
1E-8 to 1E-4	1 mA	1 MA											
< 1E-8	10 mA	10 MA											

Table 25 - Setup options IGC (continued)

Menu Option	Description
Restrike	When the Ion gauge is first switched on it is possible that the demanded emission is not achieved. When the IGC is reading pressure normally it is possible for emission to fail e.g. due to a pressure surge. Normally (with the default Restrike setting of off) either of these occurrences will lead to an emission error. The TIC will then turn off the emission demand. If the Restrike option is 'ON' after an emission error time out period the TIC will turn off emission demand and then immediately turn it back on for a second time. The emission error state is then only entered after a 2nd emission time out period. 'Scroll' to 'Restrike' and press 'Select'. 'Scroll' to change option and press 'Select' for change to occur.
Fil 1 Const	Gauge sensitivity is a unique figure for each filament which is primarily the result of gauge geometry. In an 'off the shelf' gauge head, a value will be quoted in the document accompanying the gauge (same for both filaments). A gauge head received from a calibration laboratory will come with a precise sensitivity value for each filament. This sensitivity figure needs to be entered into the TIC. Scroll to Fil 1 Const and press select. Amend the sensitivity value. See Section 4.7 changing numerical values.  <i>Note: Gauge sensitivity has units /mbar or /Torr or /pascal, the value is pressure unit dependent e.g. 6.4/mbar = 8.53/Torr.</i>
Fil 2 Const	As for Fil 1 Const above (but for Filament 2).

Figure 23 - Setup screen IGC

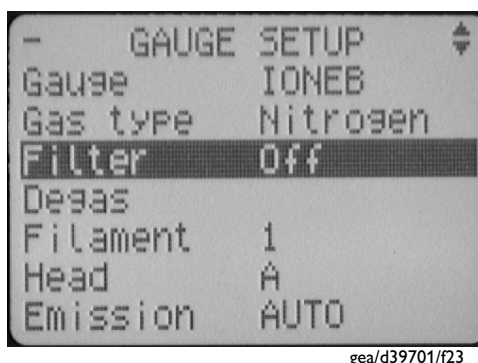

IGC has a built-in error monitoring capability. Refer to table below.

Table 26 - Diagnostic messages

Diagnostic Messages	Description
Off	Ion gauge emission is not on. Filament life will be reduced if the user attempts to turn on the gauge at pressures above $5 \times 10^{-3}$ mbar.
Inhibited	Setpoint output from gauge connected to IGC auxiliary port is bad or IGC mains is off.
Initialising	Emission cannot be established instantly after gauge is turned on as the filament power must be slowly ramped. This process can take a maximum of 22 seconds. The 'initialising' message means this start-up timer is in progress. If emission is not established before the end of the 22 second period an error message will be generated. N.B. Also see section on restrike.

Table 26 - Diagnostic messages (continued)

Diagnostic Messages	Description
Ion Em Timeout	The IGC has either failed to establish emission or lost emission. There are a large number of possible reasons for this including broken gauge head electrode or filament and disconnected cables. Other less obvious reasons include filament contamination, inappropriate head or filament selection, power supply overload or pressure too high. IGC internal pressure limit is based upon output signal voltage at 9.84 V ( $\pm 0.11$ V). If the gauge head sensitivity is 10/mbar this means pressure will need to be below $5.4 \times 10^{-3}$ mbar to guarantee emission, but as a pressure the value will vary with head sensitivity.

#### 4.8.11 Capacitance Manometer Gauges (D39702000 only)

Capacitance Manometer gauges are often abbreviated to 'Capmans' and are also referred to as using the brand model name of Barocels®.

Supported types are 600 series, 622, series, 655 series and 658 series only. For a detailed specification and instructions regarding the use of Capmans refer to the instruction manual for the specific model.

Capacitance Manometer gauges are gas independent and are available in a very wide choice of ranges. They are unique in the Edwards range of vacuum gauges in requiring a  $\pm 15$  V power supply rather than a +24 V power supply. This power supply is provided by D39702000 TIC units.

The output for all types is 0-10 V d.c. for the particular gauge range with a higher voltage indicating an over range and a negative voltage indicating that gauge head or TIC requires zeroing. Almost always the ranges are absolute so a 0-10 mbar Capman will output 10 V at 10 mbar pressure.

Capman gauge have menu options in addition to those shown at the beginning of [Section 4.8](#).

Table 27 - Setup options Capacitance Manometer

Menu option	Description
Range	<p>It is essential the correct range is selected otherwise the pressure readings will be completely erroneous. Range options are: 2000, 1000, 200, 100, 20, 2, 1, 0.2, 0.1, 0.05. 'Scroll' to 'Range' and press 'Select'. 'Scroll' to change option and press 'Select' for change to occur.</p> <p><i>Note: 0.05 mbar Capacitance Manometer gauges set to kPa will be displayed in Pascals.</i></p>
Units	<p>This is the range units NOT the display units e.g. a Capman can be a 10 Torr range but still have the pressure displayed in mbar. The correct option (mbar or Torr) must be selected to prevent erroneous pressure readings. 'Scroll' to 'Units' and press 'Select'. 'Scroll' to change option and press 'Select' for change to occur.</p>
Set Zero	<p>The output of a capacitance manometer gauge should be 0 V at the bottom of its operating range which for almost all gauges is absolute vacuum. It is quite normal to observe a small amount of drift in this zero pressure reading, either positive or negative. The zero can be reset by either using the pot on the gauge (preferable) or by introducing a corresponding offset in the TIC reading. The latter method can only be accomplished if the gauge output voltage is less than 100 mV. 'Scroll' to 'Set Zero' and press 'Select'. 'Command Sent' appears for 1 second to confirm zero demanded. If the gauge voltage is too high for the zero to take effect, a warning message will be generated.</p>

Table 27 - Setup options Capacitance Manometer (continued)

Menu option	Description
Display	The Display format for a Capman gauge can be changed from 'float' (default) to 'fixed'. Float display the channel pressure in scientific notation, that is mantissa and exponent. Fixed displays the pressure with a fixed number of decimal places. The displayed resolution depends on the selected range from the range menu.

Figure 24 - Setup screen Capacitance Manometer

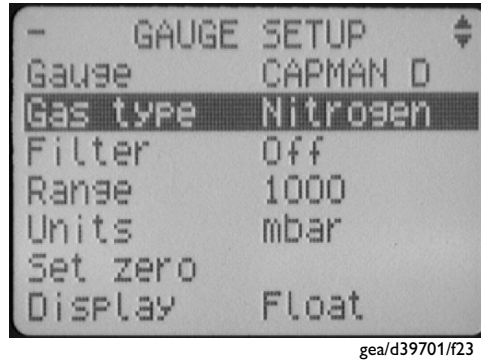

gea/d39701/f23

### 4.9 Alarms

If an Alarm occurs, an 'Alarms' warning will begin flashing in the lower half of the view screen. Refer to Figure 16.

The Alarm can then be selected by moving the cursor over it and pressing the 'Select' (↵) button. This action will take you to the Alarms screen. Alternatively the Alarms screen can be accessed through the main menu.

The Alarm will stop flashing when it has been acknowledged and will disappear when the alarm situation no longer exists. An alarm is acknowledged by pressing the 'Select' (↵) button whilst the flashing alarm is highlighted.

To clear an alarm you will need to refer to the fault finding guide in Section 5 of this instruction manual. This guide gives information of what the alarm is and the possible solutions for clearing the alarm.

### 4.10 The main menu

The main menu can be accessed by pressing the 'Menu' (☰) button on the view screen (refer to Figure 13). From here the following sub-menus can be accessed.

### 4.11 Linking gauges

When the Link Gauges option is selected from the main menu, a list of controllable items (gauges) is displayed, along with the item that is currently controlling each of them. By default, each item is 'Not Linked' indicating that nothing is in control of the item.

There are four steps to set up the link, proceed as follows:

1. Select the controlled item. Scroll to the item that is to be controlled and press the 'Select' (↵) button as shown in Figure 25.



Figure 25 - Controlled item

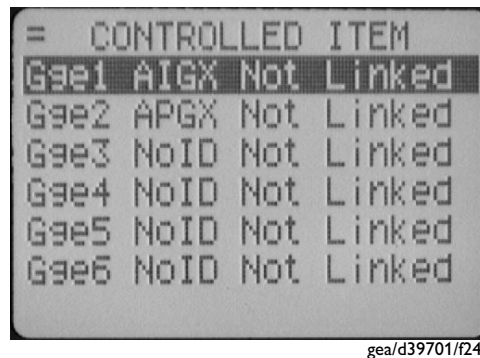

gea/d39701/f24

- Select the controlling item. The top highlighted line is used to select the controlling item. Select the controlling item from the list of those available and press the 'Select' (↵) button to confirm the choice.
- Enter the required setpoints. The 'On' and 'Off' setpoints can be adjusted to suit the application. If the controlling item is a gauge, the units can be changed between pressure (current pressure units) and voltage (V). Select the units to be used and then adjust the 'On' and 'Off' setpoints as required as shown in Figure 26.

Figure 26 - Control setup

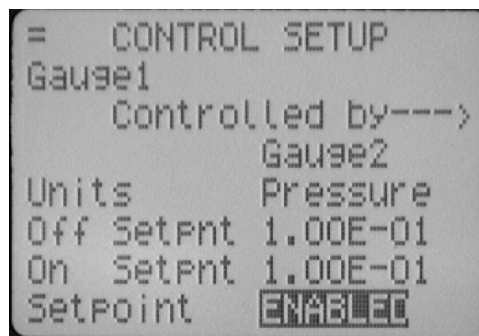

gea/d39701/f25

**Note:** For gauges: Off setpoint  $\geq$  On setpoint.

If the adjustment of either the On or Off setpoint results in the above rules being broken, the setpoint that was not adjusted will be altered to match the newly entered one.

**Note:** When entering a pressure, the sign of the exponent can only be changed when the exponent is non-zero. To set a negative exponent, the exponent value should be set first, and then the 'Menu' (☰) button used to move back to alter the sign. See Section 4.7.1.

- Enable the setpoint. Once configured, the setpoint should be enabled by changing the bottom 'Setpoint' line from 'OFF' to 'ENABLED'.

## 4.12 Parameters/Units

This screen allows the user to change the units that are displayed and other parameters such as:

- Setup lock - When the 3 digit lock code is entered, the lock is enabled and an operator will not be able to change any of the setups, however the operator is still able to scroll through the menus and start and stop pumps. The lock is disabled by entering the 3 digit unlock code. Lock - 501, unlock - 147.
- Panel Lock - This function completely locks the front panel. An operator will only be able to see the view screen. Lock - 509, unlock - 824.
- The 0 - 10 V analogue output on the logic interface can be set to follow any gauge pressure.

- Display contrast allows the user to change the contrast of the display.
- Protocol shows whether RS232 or RS485 is being used.
- Comms address - To set the comms address of the TIC.

## 4.13 Screen options

The user can use this screen to choose what order information is displayed on the view screen. The options include:

- Show all gauges - This shows all the gauges in 1X height.
- Show three gauges - This shows 3 gauges at a time in 2X height. The user can scroll to all the gauges set up to be viewed.
- Three gauge order - The user can set the order which gauges are shown.
- Show one gauge - Show 1 gauge at a time in 3X height. The user can scroll to all the gauges set up to be viewed.
- One gauge order - The user can set the order which gauges are shown.

### 4.13.1 Organising gauges on the view screen

The three gauge order and one gauge order functions are used to set up what gauges and in what order the gauges are shown on the view screen. In the following example the user wants to set the order below:

- Position 1: The gauge plugged into the 'gauge 1' connection.
- Position 2: The gauge plugged into the 'gauge 5' connection.
- Position 3: The gauge plugged into the 'gauge 2' connection.
- Position 4: The gauge plugged into the 'gauge 3' connection.
- Position 5: A gauge is not plugged into the 'gauge 4' connection, the user does not want Position 5 to be shown on the screen. The No gauge selection has been made.
- Position 6: A gauge is not plugged into the 'gauge 6' connection, the user does not want Position 6 to be shown on the screen. The No gauge selection has been made.

Figure 27 - Gauge order set up

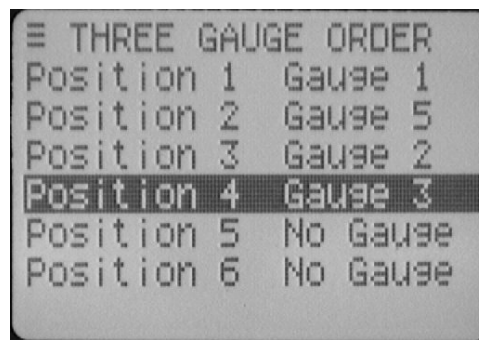

gea/d39701/f26

**Note:** The user can set up different ordering, to show three gauges or one gauge.

Once the set up is complete and the user views the screen, the gauge set up at position one is shown first. The user can scroll around to all the other gauges set up in the positions defined. In the example above only 4 positions can be scrolled to as the user has chosen that positions 5 and 6 will not be shown when you return to the main view screen.

## 4.14 Relay setpoint outputs

The relay setpoints option allows the setpoint outputs on the logic interface to be linked to a gauge pressure or pump speed. They are set up in the same way as Linking Gauges, refer to [Section 4.11](#).

When a relay setpoint becomes active, the display section on the view screen will change to reverse video.

## 4.15 Service information

Service information contains the following information:

- Software Issue - This is the issue of the currently installed software. This will change when new software is downloaded to the TIC in the future.
- Serial Number - The Serial number of the TIC is used when contacting Edwards about the product.
- Analogue O/P - The analogue output value (internal units) is used when contacting Edwards about the product.
- Reset TIC - Resets the TIC to its factory default configuration and can be used to quickly undo all user settings (links between gauges and pumps, relay setpoints, units, gauge gas types, etc).

## 4.16 Electrical supply failure

If the electrical supply to the TIC fails, any gauges connected and the logic interface will stop operating until the power is restored.

This page has been intentionally left blank.

## 5 Maintenance

### 5.1 Safety



#### WARNING

Obey the safety instructions given below and take note of the appropriate precautions. If you do not you cause injury to people and damage to equipment.

There are no serviceable parts on the TIC. Do not open, return to your nearest Edwards service centre for any repairs that are necessary.

The Edwards return of equipment forms can be found at the rear of this manual.

### 5.2 Fault finding

Table 28 - Fault finding

	Diagnostic messages	Description
Gauge	Over Range	Refer to appropriate Section in manual.
	Under Range	Refer to appropriate Section in manual.
	New ID	Refer to <a href="#">Table 12</a> .
	Uknw	Refer to <a href="#">Table 12</a> .
	Not connected	Refer to <a href="#">Table 12</a> .
	Disconnected	Refer to <a href="#">Table 12</a> .
	Not Struck	Refer to appropriate Section in manual.
	Filament Fail	Refer to appropriate Section in manual.
	Mag Fail	Refer to <a href="#">Table 24</a> .
	Striker Fail	Refer to <a href="#">Table 24</a> .
	Cal Error	Refer to <a href="#">Table 15</a> .
	Initialising	Refer to <a href="#">Table 22</a> .
	Emission Error	Refer to <a href="#">Table 22</a> .
	Over Pressure	Refer to <a href="#">Table 22</a> .
ASG Cant Zero	Refer to <a href="#">Table 19</a> .	
General	SYSI Inhibit	The system interlock has been disconnected. Please check that the logic interface plug is connected correctly, or check the status of the system interlocks.
	Ext Inhibit	Enable lines have been disconnected, please check your external inhibit lines.
	No Reading	An object has not received a value update from its source within a given time and is flagging that its value is now old. Check connections to components of system.
	No Message	An object has not received a reply to a message it sent within a given time. Check logic interface connections, are correctly attached to the TIC.
	Warning PS Temp	If this message is displayed, the unit's power supply temperature is above the manufacturer's specification, which will result in lifetime reduction and should be avoided. The following issues should be assessed: <ul style="list-style-type: none"> <li>a) Installation surrounding gaps (refer to <a href="#">Section 3.2</a>)</li> <li>b) Power output (refer to <a href="#">Section 3.3.3</a>)</li> <li>c) Ambient temperature (measured below TIC, refer to <a href="#">Section 2.2</a>)</li> </ul>
	Brownout/short	The loading on the TIC outputs exceeds a certain current level. Remove the short or high load and then accept the error, the TIC will re-attempt to drive the output.

### 5.3 Cleaning the controller

If necessary, use a soft dry cloth to clean the exterior of the Controller. Do not clean with harsh abrasives or liquids.

If the interior of the Controller requires cleaning, it is our recommendation that you return the Controller to your supplier or your nearest Edwards Service Centre.

### 5.4 Software updates

The software within the Controller and the TIC PC monitor program will be updated as part of Edwards on going development program. The updates and associated instruction manual can be found by visiting [www.upgrades.edwardsvacuum.com](http://www.upgrades.edwardsvacuum.com).

### 5.5 Factory defaults

The following is a list of factory default settings for the TIC.

Table 29 - Factory default settings

Menu option	Default
Gauge and relay slaving	- not slaved
Gas type	= Nitrogen
Gauge Filter	= Off
Name	= _ _ _ _ (4 spaces)
CapMan / ASG range	= 1000
Analogue out slaved	= NONE
Setup lock	= Off
Panel lock	= Off
Pressure units	= mbar
PC comms	= RS232
Multi-drop address	= 0
Default screen	= All
CapMan/ASG fixed/float	= Float
IGC Filament	= 1
IGC Head	= A
IGC Emission	= Auto
IGC Restrike	= Off
IGC Fil Const	= 10.0

## 6 Storage and disposal

### 6.1 Storage

Store the Controller in clean dry conditions in accordance with the technical specifications. Refer to [Section 2](#) of the main manual on the CD.

### 6.2 Disposal

Dispose of the Controller and any components safely in accordance with all-local and national safety and environmental requirements.

Alternatively, you may be able to recycle the Controller and/or cables; contact Edwards or your supplier for advice (also see below).

The Controller and associated cables are within the scope of the European Directive on Waste Electrical and Electronic Equipment, 2002/96/EC. Edwards offer European customers a recycling service for the Controller/cables at the end of the product's life. Contact Edwards for advice on how to return the Controller/cables for recycling.

This page has been intentionally left blank.



## 7 Service, spares and accessories

### 7.1 Service

A worldwide network of Edwards Service Centres supports Edward's products. Each Service Centre offers a wide range of options including equipment decontamination; service exchange; repair; rebuild and testing to factory specifications. Equipment, which has been serviced, repaired or rebuilt, is returned with a full warranty.

For more information about service options, contact your nearest Service Centre or other Edwards company.

### 7.2 Spares

Spare	Item Number
TIC Front Bezel Kit	D397-00-803
TIC Logic Interface	D397-00-850
Front Panel Assembly	D397-00-822

**Note:** This assembly is suitable for customers who have electrical and electronic repair expertise and possess a portable appliance tester. If the customer is unable to carry out this repair, the Controller should be returned to Edwards for a full repair and safety re-test.

### 7.3 Accessories

Table 30 shows the range of accessories that can be purchased.

Table 30 - Accessories

Product Description	Ordering Information
TIC Profibus Module	D397-50-000
APG-L, APG-MP, APG-M ranges	
APGX-H, APGX-L, APGX-M and APGX-MP ranges	
ATC-D and ATC-M	
ASG	
AIM-S, AIM-SL, AIM-X, AIM-XL ranges	
WRG-S and WRG-SL	
Barocel® Capacitance Manometers - TIC Instrument Controller 6-Gauge Capacitance Manometers only:	
600 Series	
622 Series	
655 Series	
658 Series	
Ion Gauge Controller	
<b>Active Gauge Cables (including FCC68 compatible connections at both ends)</b>	
0.5 m active gauge cable	D400-01-005
1 m active gauge cable	D400-01-010
3 m active gauge cable	D400-01-030
5 m active gauge cable	D400-01-050

Table 30 - Accessories (continued)

10 m active gauge cable	D400-01-100
15 m active gauge cable	D400-01-150
15 m active gauge cable (24 AWG)	D400-05-150
25 m active gauge cable	D400-01-250
30 m active gauge cable (24 AWG)	D400-05-300
50 m active gauge cable	D400-01-500
100 m active gauge cable	D400-01-999
ASG adaptor cable	D400-03-060
Barocel® 600, 655, 658, 659 series adaptor cable	D400-03-050
Barocel® 622 series adaptor cable	D400-03-030
<b>Relay Boxes</b>	
TIC Relay box 3 x 240 V	D397-00-804
TIC Relay box 6 x 240 V	D397-01-804
<b>Interface cables</b>	
2 m Logic interface cable	D397-00-833
2 m RS232 interface cable	D397-00-834
<b>Mains cables (Suitable for TIC controllers)</b>	
2 m UK plug	D400-13-025
2 m USA plug	D400-13-120
2 m Northern European plug	D400-13-120
<b>Other accessories and supporting products</b>	
TIC updates, software and manuals	<a href="http://www.upgrades.edwardsvacuum.com">www.upgrades.edwardsvacuum.com</a>

# Index

## A

Accessories .....	43
Active gauge connectors .....	3
Additional earth bonding .....	13
Alarms .....	34
Analogue outputs .....	7

## B

Bench mounted TIC dimensions (mm) .....	10
---	----

## C

Capacitance Manometer Gauges .....	33
Changing list items .....	21
Changing numerical values .....	21
Cleaning the controller .....	40
Component checklist .....	9
Connecting an active gauge .....	13
Connecting the electrical supply .....	13
Connecting the serial interface .....	15
Connections .....	3
Controller electrical connections .....	12

## D

Diagnostic messages .....	32
Disposal .....	41

## E

Electrical data .....	3
Electrical supply .....	3
Electrical supply failure .....	37
Entering negative components .....	21

## F

Factory defaults .....	40
Fault finding .....	39
Fitting the controller .....	9
Front panel display .....	17
Front panel removal .....	11
Fuse .....	3

## G

Gauge order set up .....	36
Gauge setup .....	22

## I

Installation .....	9
Ion Gauge Controller (IGC) .....	31

## L

Linking gauges .....	34
Logic connector Edwards accessories .....	14

Logic interface .....	4
-----------------------	---

## M

Maintenance .....	39
Mechanical data .....	3
Menu structure .....	18

## O

Operating and storage data .....	3
Operation .....	17
Organising gauges on the view screen .....	36
Other gauges .....	13

## P

Panel cut out drawing .....	12
Pin allocation for analogue outputs .....	7
Pin connection for 4-way analogue output connector .....	7

## R

Relay setpoint outputs .....	37
------------------------------	----

## S

Safety .....	39
Scope and definitions .....	1
Serial communications .....	6
Service .....	43
Service information .....	37
Setup options Capacitance Manometer .....	33
Software updates .....	40
Spares .....	43
Storage .....	41
Storage and disposal .....	41

## T

Technical data .....	3
----------------------	---

## U

Unpack and inspect .....	9
Using control inputs .....	14
Using status outputs .....	15

This page has been intentionally left blank.